

# Technics

Stereo Double Cassette Deck

RS-TR155

RS-TR255

## OPERATING INSTRUCTIONS



RS-TR155

RS-TR255

Before operating this unit, please read these instructions completely.

## To Our Valued Customer

Technics, The Science of Sound, welcomes the challenge of new audio technologies and brings you a multitude of world-renowned, high quality audio components, all backed by our time-honored commitment to innovation, value, and quality.

Technics captures the power of new ideas and turns them into high performance components like digital compact disc players that feature High Speed Linear Motor Transports, high speed editing cassette decks, professional and consumer turn-

tables, Computer Drive New Class A amplifiers, and A/V receivers that integrate both audio and video equipment.

The Technics list of advanced audio components continues. From Class AA amplifiers, honeycomb disc speakers, and multi-disc CD changers to the world's first touch-sensitive graphic equalizer, Technics is a shining example of audio technology at its best.

# Contents

• <b>Suggestions for safety</b> .....	3	• <b>Edit-Recording</b> .....	12
• <b>Accessories</b> .....	4	• <b>Convenient Features for Recording</b> .....	13
• <b>Connections</b> .....	4	• <b>Timer Recording/Playback</b> .....	14
• <b>About Cassette Tapes</b> .....	5	• <b>After Recording</b> .....	14
• <b>Maintenance</b> .....	5	• <b>Technical Specifications</b> .....	15
• <b>Front Panel Controls and Functions</b> .....	6	• <b>Troubleshooting Guide</b> .....	15
• <b>Playback</b> .....	8	• <b>Product Service</b> .....	Back cover
• <b>Recording</b> .....	11		

**These operating instructions are applicable to models RS-TR155 and RS-TR255.  
These operating instructions, however, fundamentally explain the operation of model RS-TR155.**

The model number and serial number of this product can be found on either the back or the bottom of the unit. Please note them in the space provided below and retain this booklet as a permanent record of your purchase to aid identification in the event of theft.

MODEL NUMBER .....

SERIAL NUMBER .....

### CAUTION

- This equipment has been tested and found to comply with the limits for a Class B computing device in accordance with the specifications set forth in Subpart J of Part 15 of the FCC Rules. If this equipment does cause interference to radio or television reception which can be determined by turning the equipment on and off, use the equipment in another location and/or utilize an electrical outlet different from that used by the receiver.
- This digital apparatus does not exceed the Class B limits for radio noise emissions from digital apparatus set out in the Radio Interference Regulations of the Canadian Department of Communications.
- **TO PREVENT ELECTRIC SHOCK MATCH WIDE BLADE OF PLUG TO WIDE SLOT, FULLY INSERT.**

**WARNING:**  
**TO REDUCE THE RISK OF FIRE OR ELECTRIC SHOCK, DO NOT EXPOSE THIS APPLIANCE TO RAIN OR MOISTURE.**



**CAUTION:** TO REDUCE THE RISK OF ELECTRIC SHOCK, DO NOT REMOVE SCREWS. NO USER-SERVICEABLE PARTS INSIDE. REFER SERVICING TO QUALIFIED SERVICE PERSONNEL.



The lightning flash with arrowhead symbol, within an equilateral triangle, is intended to alert the user to the presence of uninsulated "dangerous voltage" within the product's enclosure that may be of sufficient magnitude to constitute a risk of electric shock to persons.



The exclamation point within an equilateral triangle is intended to alert the user to the presence of important operating and maintenance (servicing) instructions in the literature accompanying the appliance.

# Suggestions for Safety

Before using this unit, be sure to read applicable items of the operating instructions and these safety suggestions carefully. Afterwards keep them handy for future reference. Take special care to follow the warnings indicated on the unit itself as well as in the operating instructions.

- 1. Water and Moisture** - The unit should not be used near water - for example, near a bathtub, washbowl, kitchen sink, laundry tub, in a wet basement, or near a swimming pool, and the like.
- 2. Object and Liquid Entry** - Care should be taken so that objects do not fall and liquids are not spilled into the enclosure through openings.
- 3. Ventilation** - The unit should be situated so that its location or position does not interfere with its proper ventilation. For example, the unit should not be situated on a bed, sofa, rug, or similar surface that may block the ventilation openings; or placed in a built-in installation, such as a bookcase or cabinet that may impede the flow of air through the ventilation openings.
- 4. Heat** - The unit should be situated away from heat sources such as radiators, heat registers, stoves, or other unit that produce heat.
- 5. Power Sources** - The unit should be connected to a power supply only of the type described in the operating instructions or as marked on the unit.
- 6. Power Cord Protection** - AC power supply cords should be routed so that they are not likely to be walked on or pinched by items placed upon or against them, paying particular attention to cords at plugs, convenience receptacles, and the point where they exit from the unit. Never take hold of the plug or cord if your hand is wet, and always grasp the plug body when connecting or disconnecting it.
- 7. Polarization** - If the unit is equipped with a polarized AC power plug (a plug having one blade wider than the other), that plug will fit into the AC outlet only one way. This is a safety feature. If you are unable to insert the plug fully into the outlet, try reversing the plug. If the plug should still fail to fit, contact your electrician to replace your obsolete outlet. Do not defeat the safety purpose of the polarized plug.
- 8. Carts and Stands** - The unit should be used only with a cart or stand that is recommended by the manufacturer. The unit and cart combination should be moved with care. Quick stops, excessive force, and uneven surfaces may cause the unit and cart combination to overturn. 
- 9. Wall or Ceiling Mounting** - The unit should be mounted to a wall or ceiling only as recommended by the manufacturer.
- 10. Cleaning** - The unit should be cleaned only as recommended by the manufacturer.

- 11. Outdoor Antenna Grounding** - If an outside antenna is connected to the receiver, be sure the antenna system is grounded so as to provide some protection against voltage surges and built-up static charges. Section 810 of the National Electrical Code, ANSI/NFPA No. 70 - 1984, provides information with respect to proper grounding of the mast and supporting structure, grounding of the lead-in wire to an antenna discharge unit, size of grounding conductors, location of antenna-discharge unit, connection to grounding electrodes, and requirements for the grounding electrode. See figure below.

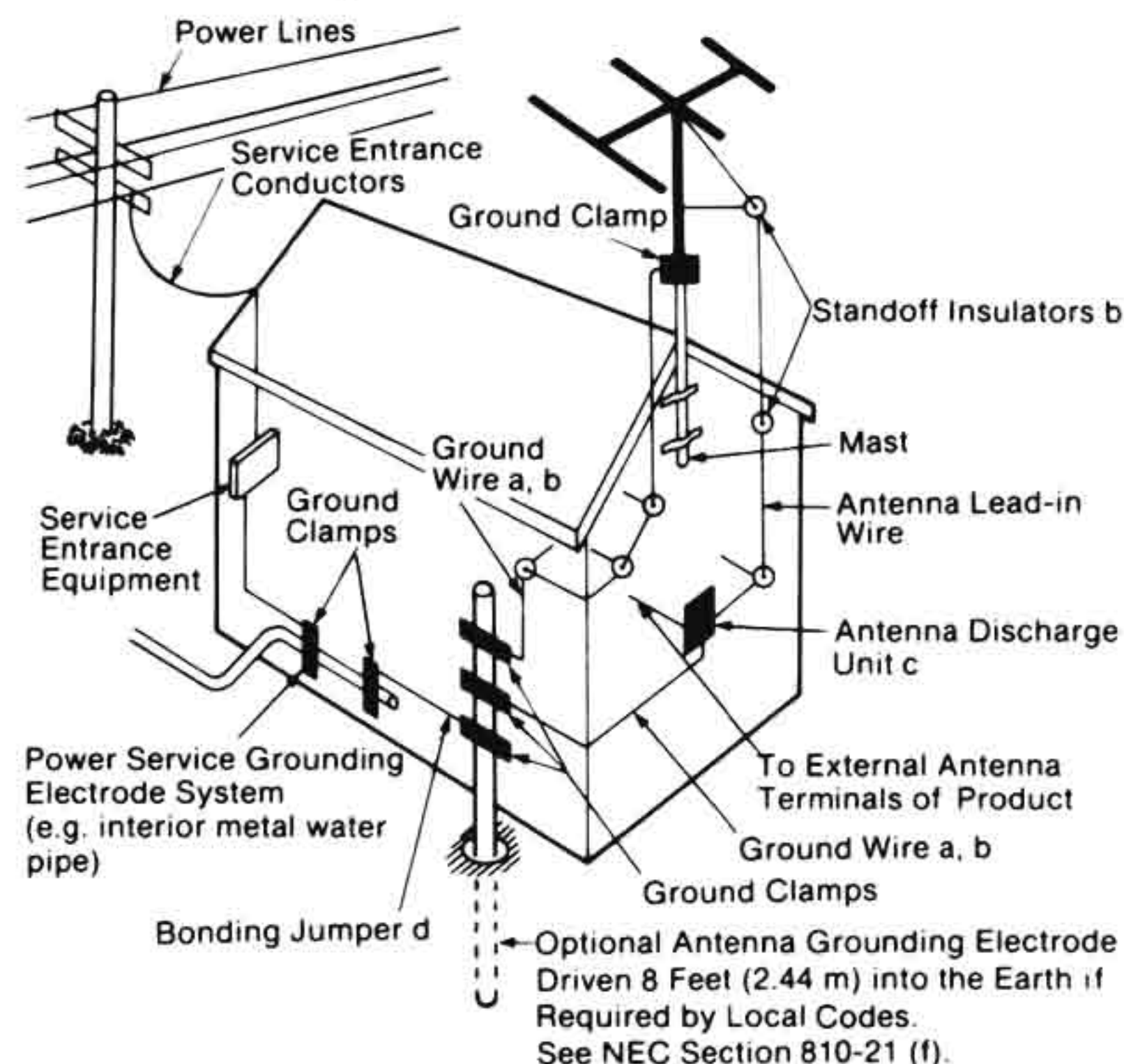

- Use No. 10 AWG (5.3 mm<sup>2</sup>) copper, No. 8 AWG (8.4 mm<sup>2</sup>) aluminum, No. 17 AWG (1.0 mm<sup>2</sup>) copper-clad steel or bronze wire, or larger, as a ground wire.
- Secure antenna lead-in and ground wires to house with stand-off insulators spaced from 4 feet (1.22 m) to 6 feet (1.83 m) apart.
- Mount antenna discharge unit as close as possible to where lead-in enters house.
- Use jumper wire not smaller than No. 6 AWG (13.3 mm<sup>2</sup>) copper, or the equivalent, when a separate antenna-grounding electrode is used. See NEC Section 810-21 (j).

- 12. Power Lines** - An outdoor antenna should be located away from power lines.
- 13. Nonuse Periods** - The AC power supply cord of the unit should be unplugged from the household AC outlet when left unused for a long period of time.
- 14. Damage Requiring Service** - The unit should be serviced by qualified service personnel when:
  - The AC power supply cord or the plug has been damaged; or
  - Objects have fallen or liquid has been spilled into the unit; or
  - The unit has been exposed to rain; or
  - The unit does not appear to operate normally or exhibits a marked change in performance; or
  - The unit has been dropped, or the enclosure damaged.
- 15. Servicing** - The user should not attempt to service the unit beyond that described in the operating instructions. All other servicing should be referred to qualified service personnel.

# Accessories

- Stereo connection cables..... 2  
(Refer to page 4.)
- L-type cables..... 2  
(SJP2257T) (Refer to page 4.)
- AC power supply cord (polarized).... 1  
(Refer to page 4.)

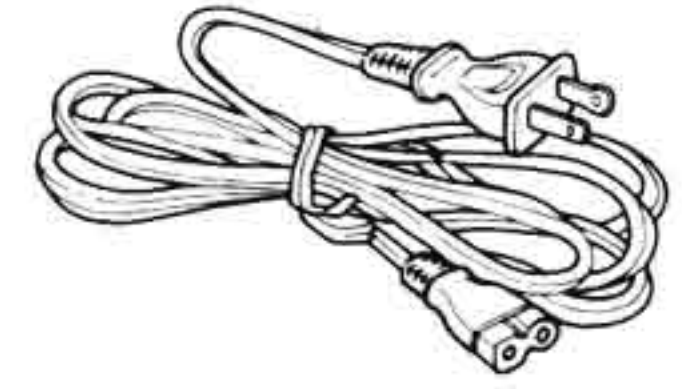
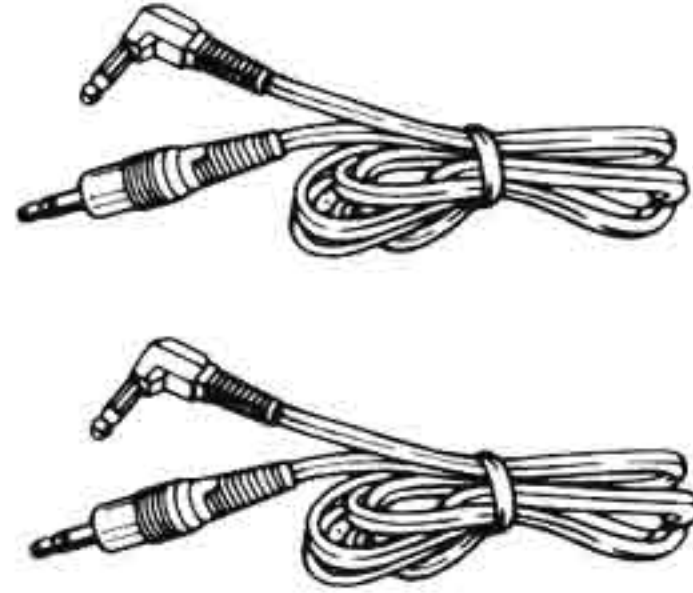
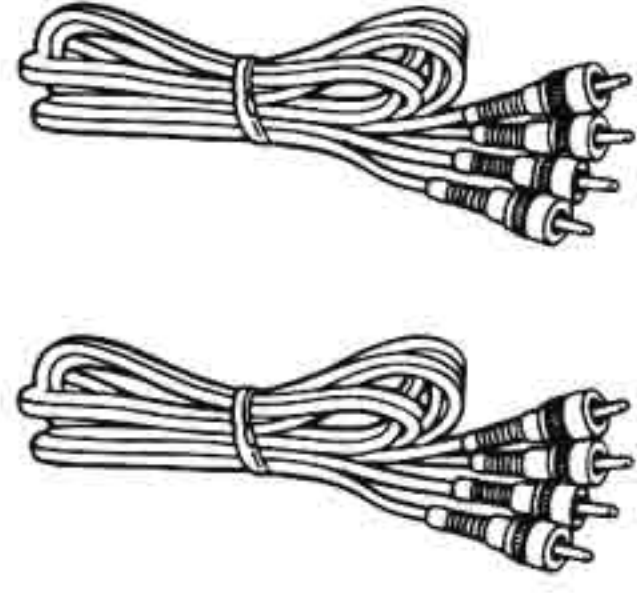

# Connections

Make connections in the numbered sequence by using the included cables.

- 1** Connect the stereo connection cables.
- 2** Connect the L-type cables.
- 3** Connect the AC power supply cord.

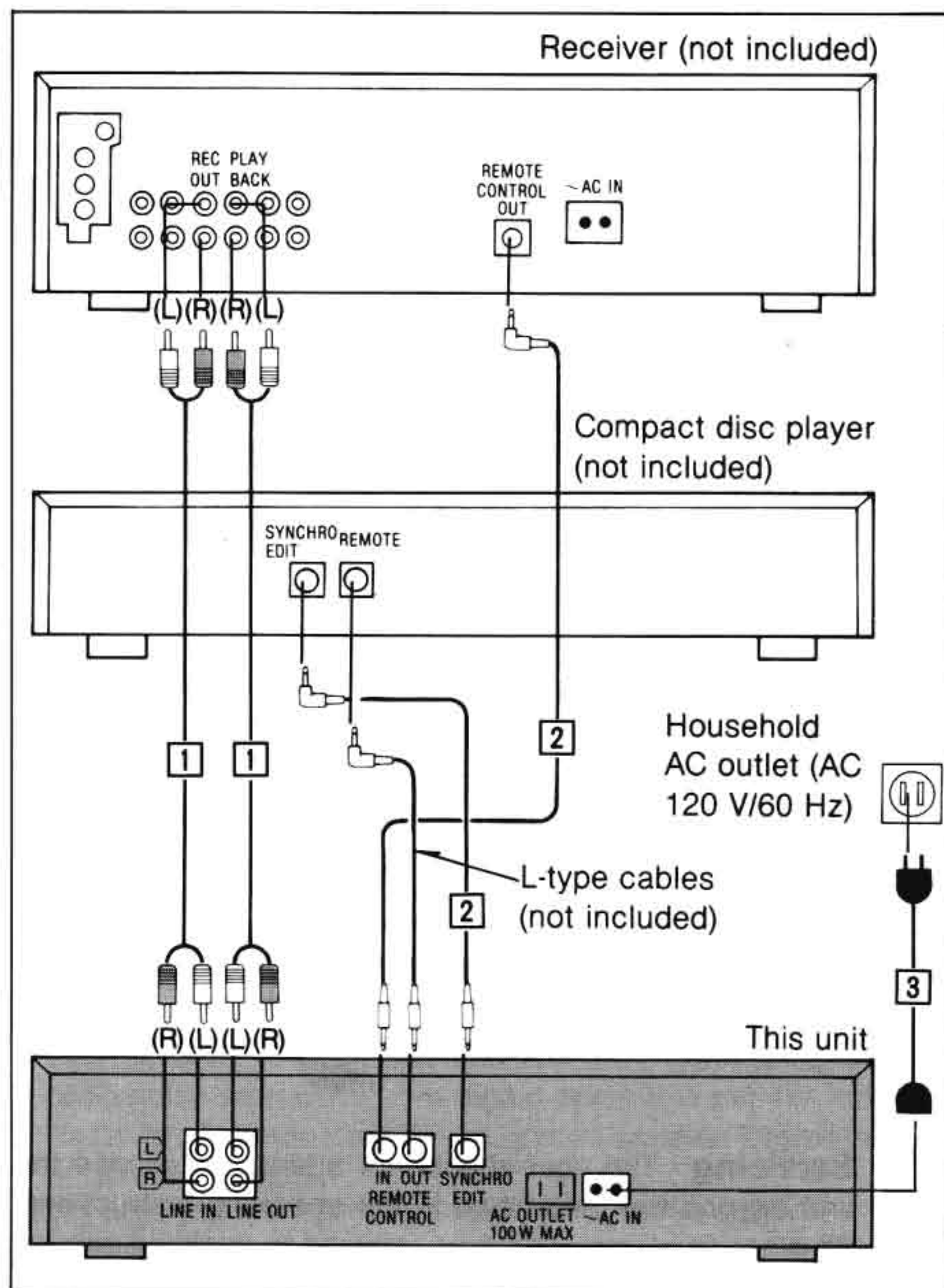

The illustration at the left shows an example of connections made when this unit is combined with a Technics hi-fi component system, and shows only the connections to be made to and from this unit in that combination.

Refer to the illustration together with the instructions provided below.

## “REMOTE CONTROL IN” terminal

Make a connection from this terminal to the control terminal for a cassette deck with a Technics receiver or a Technics amplifier. (For detailed information, refer to the operating instructions of the Technics receiver or the Technics amplifier.)

## “REMOTE CONTROL OUT” terminal

Make a connection from this terminal to the “REMOTE INPUT” terminal of a Technics graphic equalizer or to the “REMOTE” terminal of a Technics compact disc player. (For detailed information, refer to the operating instructions of the Technics graphic equalizer or the Technics compact disc player.)

## “SYNCHRO EDIT” terminal

Make a connection from this terminal to a terminal that has the synchro-edit function of a Technics compact disc player. (For detailed information, refer to the operating instructions of the Technics compact disc player.)

## “AC OUTLET”

This outlet is a unswitched outlet. Power is always available, regardless of unit's power switch setting. This outlet is only for use with other audio equipment. Also, do not exceed the indicated power rating when connecting to this outlet.

## Placements hints

If this unit is placed near a receiver or a tuner, a “hum” noise may be heard during tape playback, recording, or AM reception of the receiver or the tuner. If this occurs, leave as much space as possible between the units, or place them where there is the least amount of “hum”.

# About Cassette Tapes

## Avoid the following types of tapes

- **120-minute (or longer) tapes**

Because this tape is very thin, it might stretch during use, become tangled with rotating parts in this unit, and/or tape movement might not be stable.

- **Fe-Cr tape (TYPE III)**

The high range will be emphasized and a flat frequency response characteristic cannot be obtained.

- **Metal tape without detection holes in the cassette**

Recordings will be very distorted. (There is no playback problem, however.)

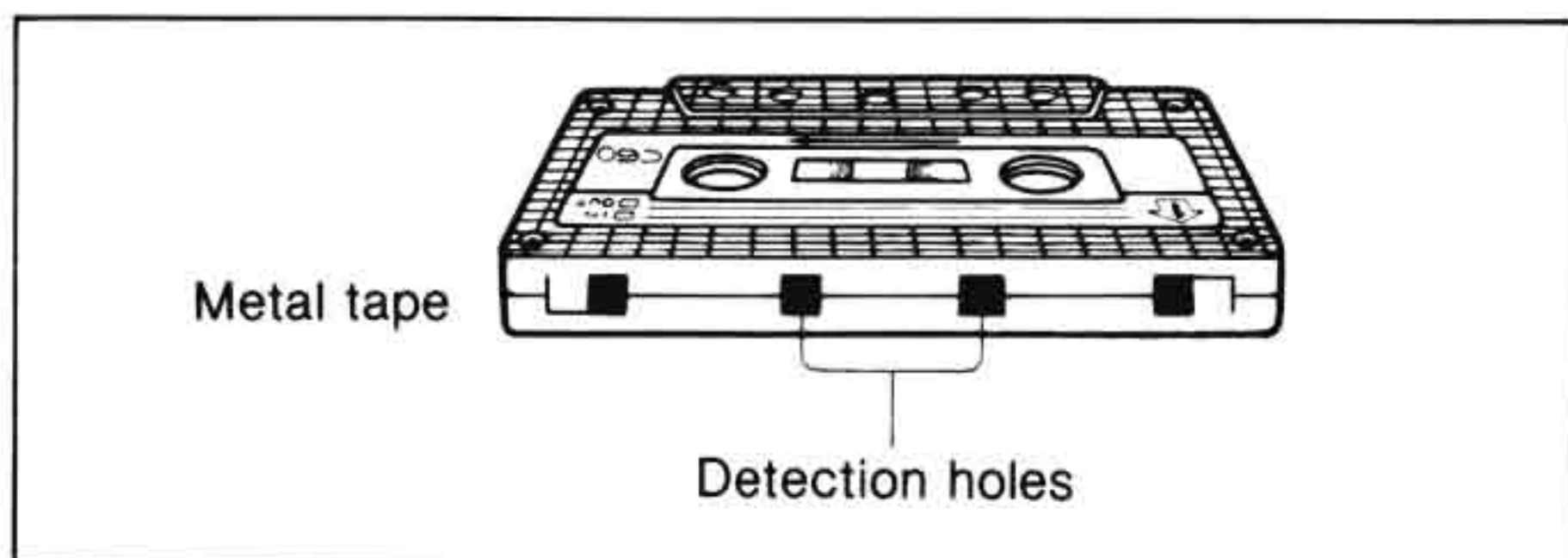

## Notes about the handling of cassettes

If the tape in the cassette is loose, the tape can easily break during use or otherwise be damaged.

Never touch the tape itself, or attempt to pull it out of the cassette.

Use a pencil or similar object to take up the slack.

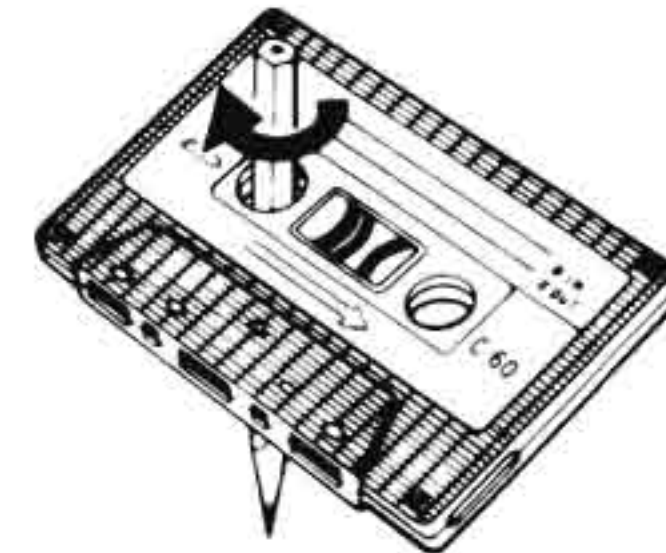

## Avoid tape storage in the following places

Tape can be damaged if it is stored in places such as described below.

- Where the temperature is high (95° F/35° C or higher) or where the humidity is high (80% or higher).
- Where there is a strong magnetic field (near a speaker, on top of a TV, etc.).
- In direct sunlight.

# Maintenance

## Head care

To assure good sound quality for recording and playback, be sure to clean the heads after approximately every 10 hours of use.

- 1) Press the power switch to switch OFF the power supply.
- 2) Press the eject button.
- 3) Clean the heads, pinch roller and the capstan shaft of each deck with a cotton swab (or with a soft, lint-free cloth) slightly moistened with alcohol.

Do not use any solution other than alcohol for head cleaning.

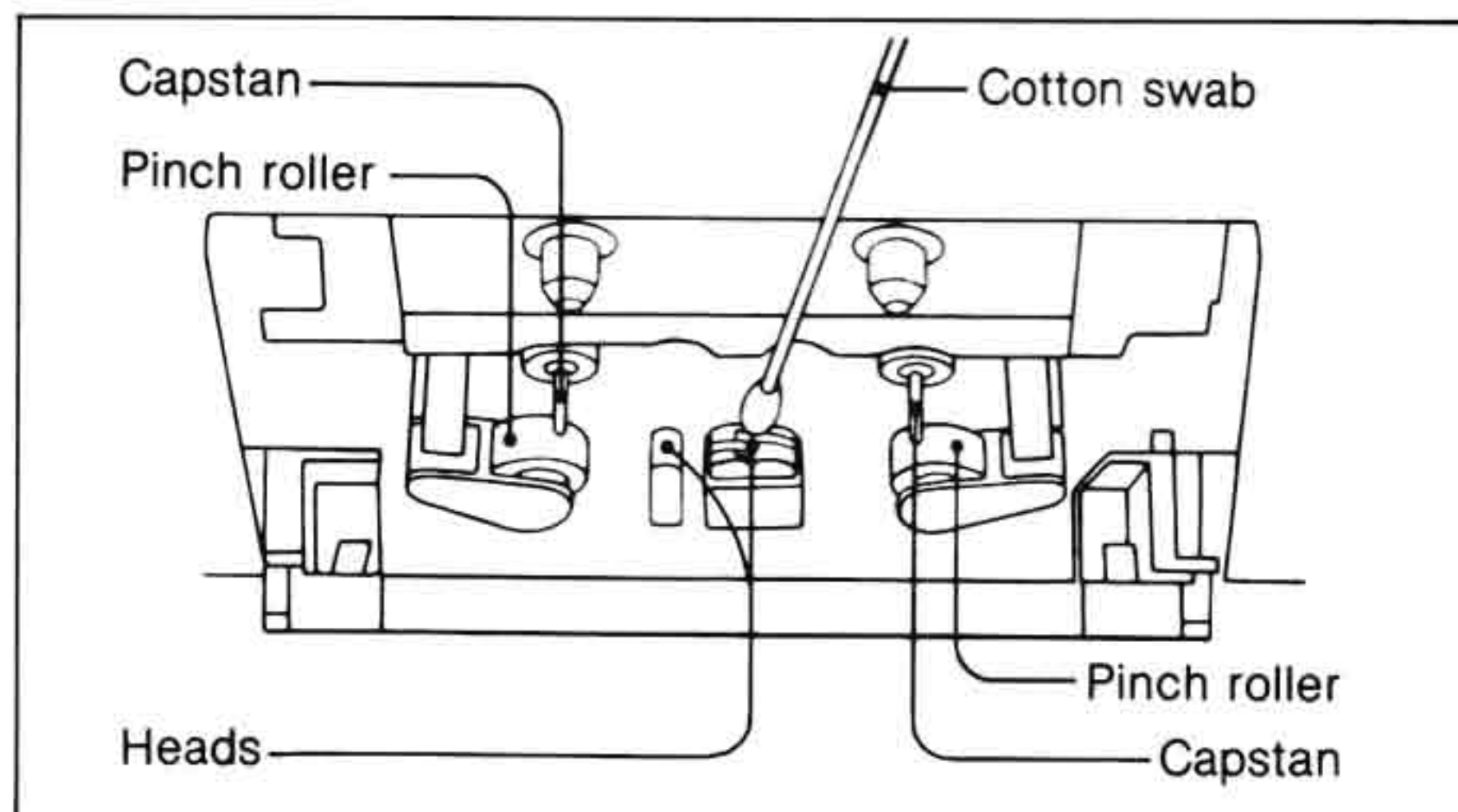

## Head demagnetization

In order to maintain good sound quality during recording and playback, it is recommended that the heads should be demagnetized if distortion or poor sound quality persist after cleaning the heads.

If the heads become magnetized, they could create noise in recordings, loss of high-frequency response, or erasure of valuable recordings. Several types of head demagnetizers are available and may be purchased at local electronics supply stores. Follow the instructions that are supplied with the device.

- Do not bring any type of metal objects or tools such as magnetic screwdrivers in contact with the head assembly.

## Maintenance of external surfaces

To clean this unit, use a soft, dry cloth.

For very dirty surfaces, dip a soft cloth in a weak soap-and-water solution and wring well. After cleaning, wipe with a soft, dry cloth.

Never use alcohol, paint thinner, benzene, or a chemically treated cloth to clean this unit.

Such chemicals may damage the unit's finish.

# Front Panel Controls and Functions

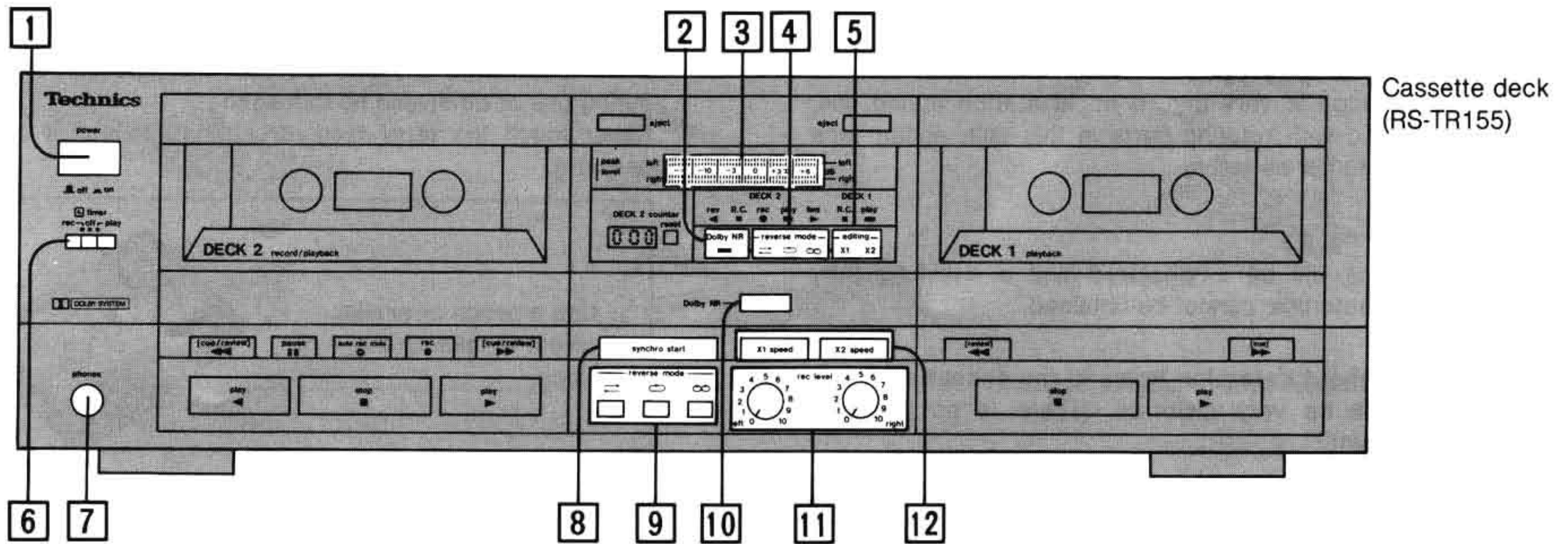

## Controls common to both tape decks

### 1 Power switch (power)

### 2 Dolby noise-reduction indicator

This indicator illuminates when the Dolby noise-reduction button is pressed.

#### For RS-TR255 only

### Dolby noise-reduction indicators (B, C)

Each indicator illuminates to show the type of Dolby noise-reduction system selected by pressing one of the Dolby noise-reduction buttons.

### 3 Input level meter (peak level)

During playback, this meter indicates the level of the recorded sound.

During recording, it indicates the level being recorded, adjusted by the recording-level controls.

### 4 Reverse-mode indicators (←, →, ∞)

Each indicator illuminates to show which of the reverse modes was selected by the reverse-mode selectors.

### 5 Edit-recording tape-speed indicators (x1, x2)

Each indicator illuminates to show which of the tape-to-tape recording speeds was selected when pressing one of the edit-recording tape-speed buttons.

### 6 Timer switch (timer)

This switch is used to automatically begin a tape recording or tape playback at a certain time, selected by an optional timer. (Refer to page 14.)

### 7 Headphones jack (phones)

### 8 Synchro-start button (synchro start)

This button is used to start a tape-to-tape recording, simultaneously starting deck 1 (the playback deck) and deck 2 (the recording deck). (Refer to page 12.)

### 9 Reverse-mode selectors (reverse mode)

These selectors are used for selection of the reverse mode (for either playback or recording). (Refer to pages 9, 11 and 12.)

### 10 Dolby noise-reduction button (Dolby NR)

This button is used to reduce the "hissing" noise heard from the tape.

#### For RS-TR255 only

### Dolby noise-reduction buttons (Dolby NR)

These buttons are used to reduce the hissing noise heard from the tape. This unit is provided with both the B-type and C-type noise-reduction systems. (Refer to page 9.)

### 11 Recording-level controls (rec level)

These controls are used to regulate the recording level of deck 2. (Refer to page 11.)

### 12 Edit-recording tape-speed buttons (speed)

These buttons are used to select the recording speed during edit-recording. (Refer to page 12.)

## Remote-control operation

The following functions can be operated by remote-control (When connected to the appropriate Technics amplifier or receiver): Playback, Stop, Pause, Fast-forward/cue, Rewind/review, Record, Auto record mute, and 1-2 (A-B) deck selection.

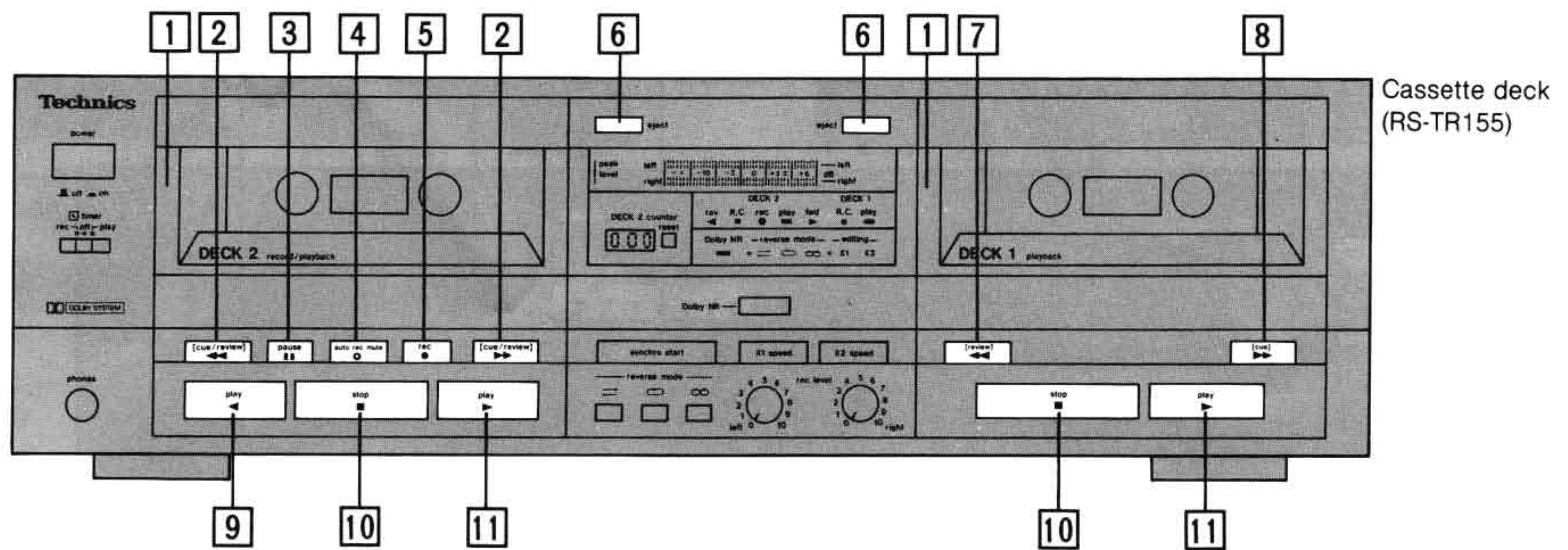

## Controls applicable to tape deck 1 and/or 2

- 1 Cassette holder**
- 2 Fast-forward/cue, rewind/review buttons (cue/review/◀◀/▶▶)**  
These buttons are used to advance or rewind the tape. During playback these buttons are used to cue or review while listening to the contents at high speed. (Refer to page 10.)
- 3 Pause button (pause/||)**  
This button is used to temporarily stop the tape playback or recording of deck 2 only.
- 4 Automatic-record-muting button (auto rec mute/⊙)**  
This button is used to make a silent interval on the tape while recording is in progress. (Refer to page 13.)
- 5 Record button (rec/●)**  
This button is used to set deck 2 to the recording stand-by mode.
- 6 Eject button (eject)**  
This button is used to open the cassette holder.
- 7 Rewind/review button (review/◀◀)**  
This button is used to rewind the tape. During playback this button is used to review the contents at high speed. (Refer to page 10.)
- 8 Fast-forward/cue button (cue/▶▶)**  
This button is used to advance the tape. During playback this button is used to cue the contents at high speed. (Refer to page 10.)
- 9 Reverse-side playback button (play/◀)**  
This button is used to start the playback or recording of side "B" of the cassette in deck 2. (The tape will move in the right-to-left direction.)

- 10 Stop button (stop/■)**  
This button is used to stop the tape movement.

- 11 Forward-side playback button (play/▶)**  
This button is used to start the playback or recording (of deck 2 only) of side "A" of the cassette. (The tape will move in the left-to-right direction.)

## Indicators applicable only to tape deck 1 or 2

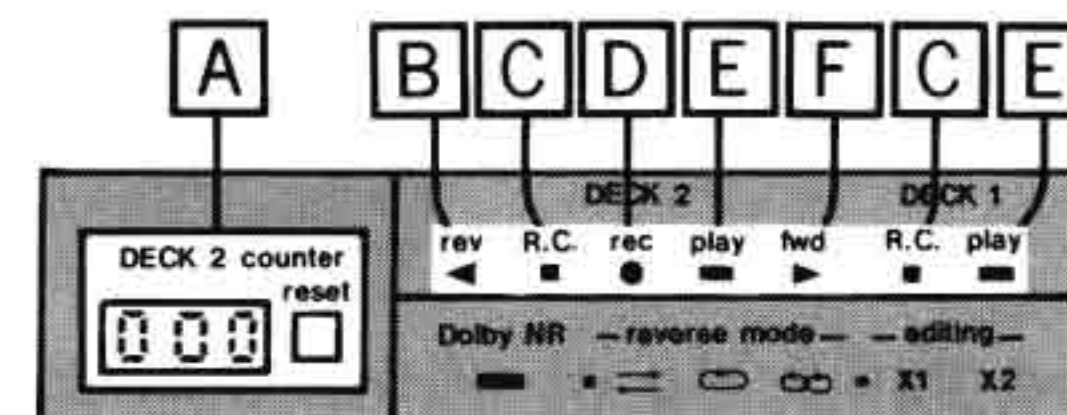

- A Tape deck 2 counter/reset button (DECK 2 counter/reset)**  
This counter registers the amount of tape travel in deck 2. The reset button is used to reset the tape counter reading to "000".
- B Reverse-side indicator (rev/◀)**  
Illuminates during playback or recording of deck 2, to indicate that side "B" of the tape is being used.
- C Remote-control indicator (R.C.)**  
Illuminates to indicate that this unit can now be controlled by the remote-control transmitter.
- D Recording indicator (rec)**  
Illuminates to indicate that deck 2 is in the recording stand-by mode.
- E Playback indicator (play)**  
When this indicator illuminates steadily, it indicates that this unit is in the playback or recording mode (of deck 2 only). When flashing continually, indicates that deck 2 is in the pause mode or in the recording stand-by mode.
- F Forward-side indicator (fwd/▶)**  
Illuminates during playback or recording of deck 2, to indicate that side "A" of the tape is being used.

# Playback

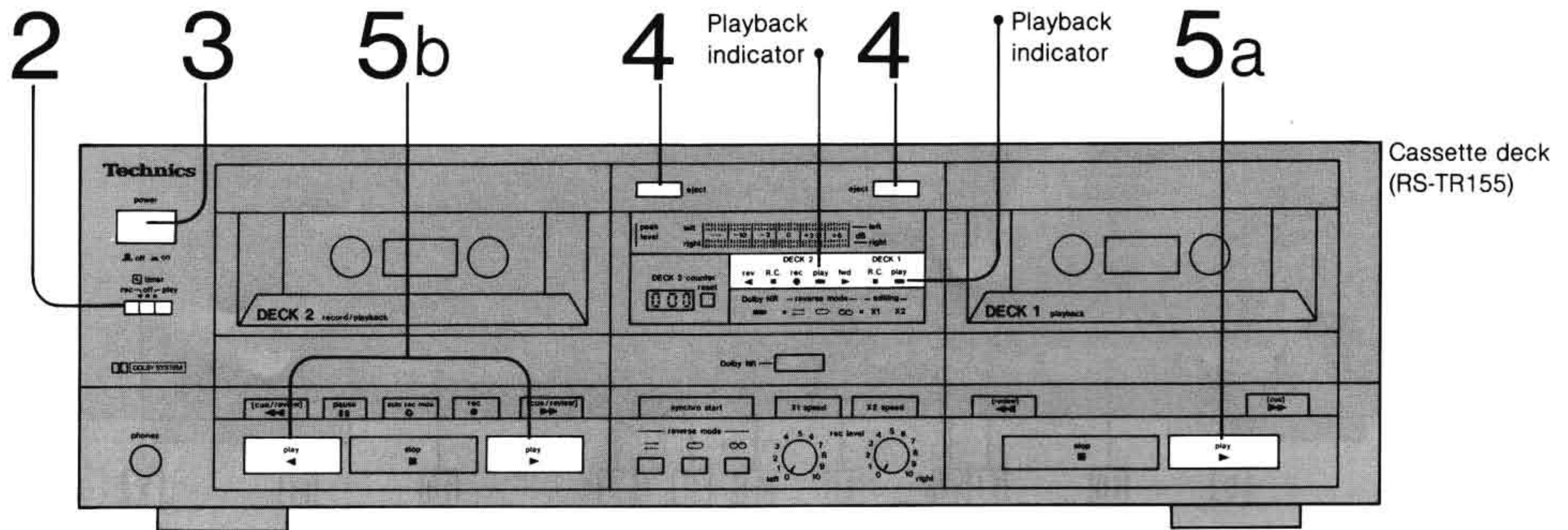

**1** Switch ON the amplifier, and select its "tape" input source.

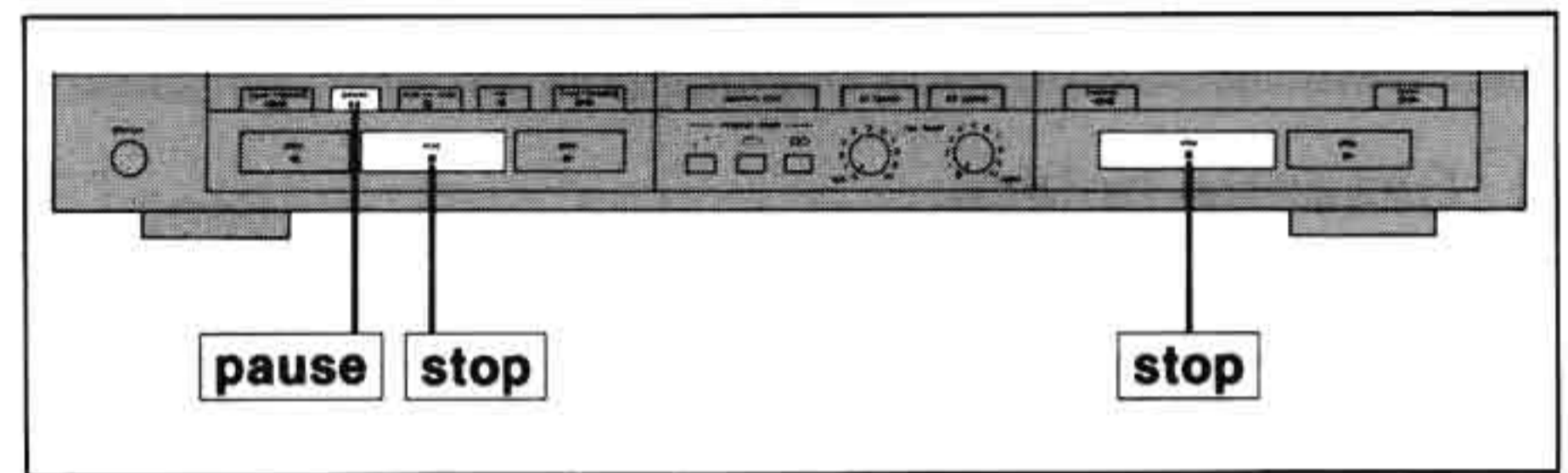

**2** **timer**  
Switch OFF the timer switch.

**3** **power**  
Switch ON the power switch.

**4** **eject**  
Press the eject button for deck 1 or deck 2 to be used for playback, and then insert the cassette tape.

(The part of the cassette where the tape is exposed should face downward.)

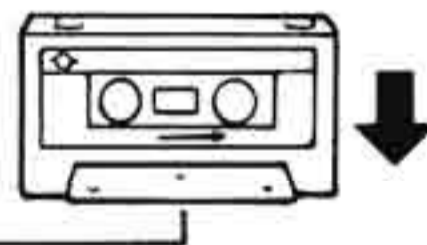

**5a** **play**  
Press the playback button.

(The playback indicator will illuminate, and playback will begin.)

**5b** **Deck 2 only**

play/▶ : Plays side "A". (side facing outward)

play/◀ : Plays side "B".

(The playback indicator will illuminate, and playback will begin.)

■ To temporarily stop playback (deck 2 only)

**pause** Press the pause button.

(The playback indicator will begin flashing.)

To resume playback, press the play button corresponding to the side of the tape being played.

■ To stop playback

**stop** Press the stop button.

(The playback indicator will switch OFF.)

## ■ Notes

- Deck 1 and deck 2 cannot be used for playback at the same time.
- Do not press the eject button while the tape is moving; doing so might cause a malfunction or damage the tape.
- While deck 2 is being used to make a recording (from LINE-IN), deck 1 can be used for fast-forwarding or rewinding a tape.
- Should the playback button of one of the decks be pressed while the other deck is in the play mode, playback of the first deck will stop.
- If noise is heard while listening to a tape, switch OFF the power of the compact disc player.



## To listen to a Dolby NR recorded tape

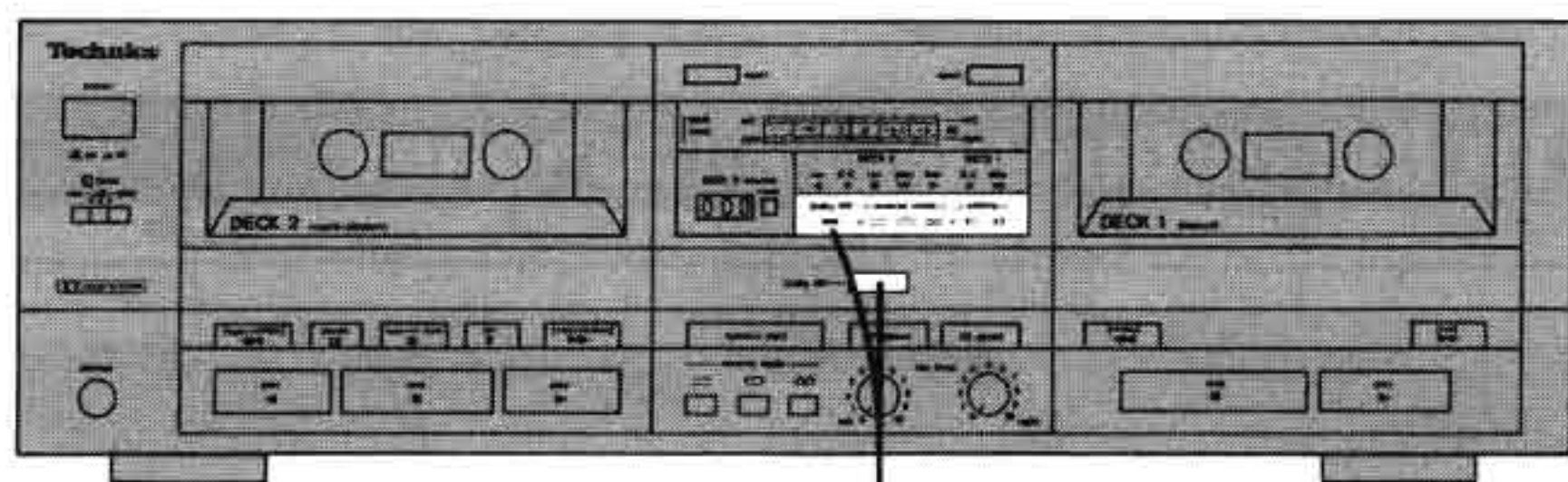

Set the Dolby noise-reduction button to ON.  
(The indicator will illuminate.)

### For RS-TR255

Dolby noise-reduction indicators

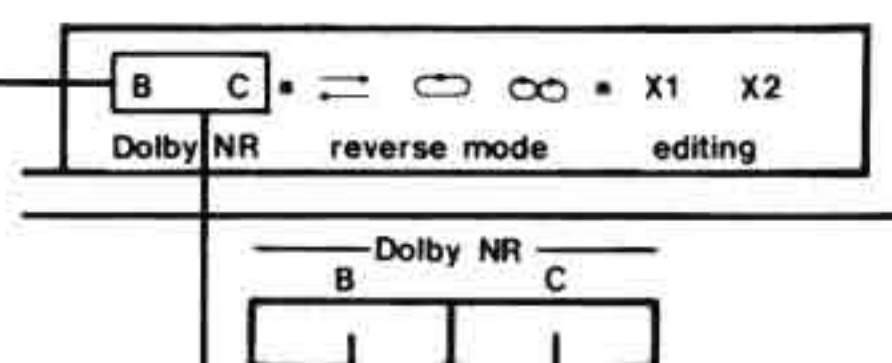

If neither Dolby noise-reduction system was used, press the button corresponding to the Dolby noise-reduction indicator that is illuminated. (The indicator will then switch OFF.)

Press if the tape was recorded by the type-B Dolby NR system. (The "B" Dolby noise-reduction indicator will then illuminate.)

Press if the tape was recorded by the type-C Dolby NR system. (The "C" Dolby noise-reduction indicator will then illuminate.)

## About the Dolby noise-reduction recording/playback system

The Dolby noise-reduction system is a system designed to effectively reduce the annoying high-frequency "hissing" noise typically heard from tapes if this system is not used. During recording, the system functions to increase the level of the high-frequency part of the sound, and then, during playback, that same portion is weakened and returned to the previous level.

### For RS-TR155

This unit is equipped with the B-type Dolby noise-reduction system.

### For RS-TR255

This unit includes two types of Dolby noise-reduction systems, the Dolby B NR-type and C NR-type.

#### ■ Dolby B-type noise-reduction system

Noise is reduced to about one-third.

Use this system when playing back tapes recorded by the Dolby noise-reduction system, such as prerecorded music tapes, etc.

#### ■ Dolby C-type noise-reduction system

Noise is reduced to about one-tenth.

Use this system for the recording and playback of sound sources that have a wide dynamic range and good tone quality, such as FM broadcasts of live performances, etc., and for playing back such tapes.

Dolby noise-reduction manufactured under license from Dolby Laboratories Licensing Corporation.  
"DOLBY" and the double-D  symbol are trademarks of Dolby Laboratories Licensing Corporation.

## Various playback functions

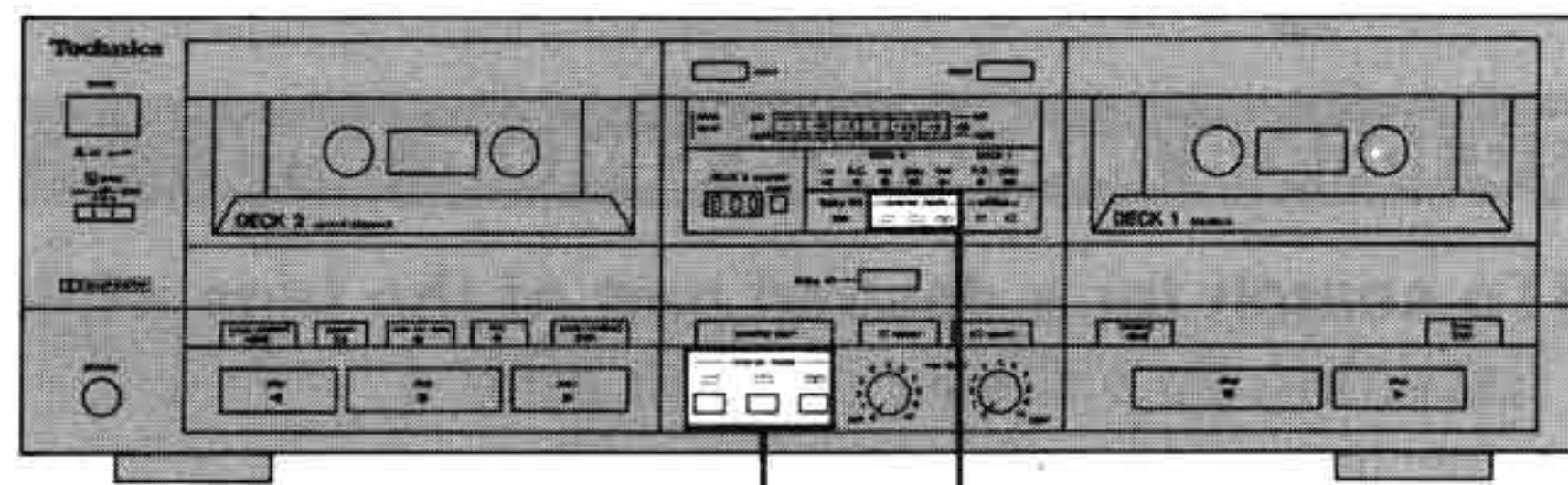

Reverse-mode selectors

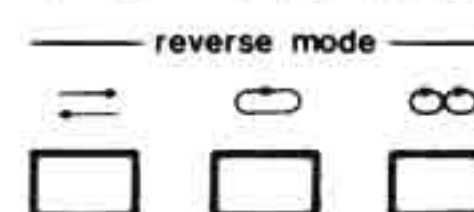

Reverse-mode indicators

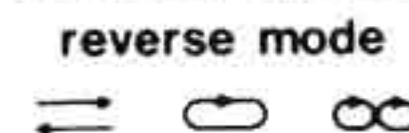

The reverse-mode selectors are used to select either of three different playback modes.

### => Select this mode to playback only one side of a cassette tape.

(The "=>" reverse mode-indicator will then illuminate.)

When the playback has finished, tape movement will stop automatically.

### <=> For deck 1

#### Select this mode to playback only one side of a cassette tape continuously.

(The "<=>" reverse-mode indicator will then illuminate.)

(After play completion of side "A", the tape will be automatically rewound.)

This playback will continue eight times or until the stop button is pressed.

### infinity For deck 2

#### Select this mode to playback both sides of a cassette tape continuously.

(The "infinity" reverse-mode indicator will then illuminate.)

This playback will continue eight times or until the stop button is pressed.

(One "time" is counted when side "B" of the tape finishes playback. If playback is started from side "B", side "A" will play only seven times.)

### infinity Select this mode to playback both sides of a cassette tape in deck 2 and only one side of a cassette tape in deck 1 continuously. (This is called "series playback".)

(The "infinity" reverse-mode indicator will then illuminate.)

This mode is convenient for enjoyment of a long period of uninterrupted background music.

Both sides (from side "A" to side "B") of the tape in deck 2 are played first, and then only one side of the tape in deck 1. After play completion of side "A" by deck 1, the tape will be automatically rewound. This playback will continue eight times or until the stop button is pressed.

(One "time" is counted when side "A" of the tape in deck 1 finishes playback. If playback is started from deck 1, the tape in deck 2 will play only seven times.)

Likewise, if playback is started from side "B" of the tape in deck 2, side "A" of the tape in deck 2 will be played only seven times.)

# Playback (continued)

## To locate and play a certain tune

### To search for a desired part of the tape while listening to sounds at high speed

This function is convenient for locating the beginning of a tune (non-recorded portion) since sound monitoring is possible while searching.

Press and hold the rewind/review, or fast-forward/cue button (deck 1 or 2) during playback. Normal playback will resume from the point where the button is released.

#### During playback of side "A" (forward) (▶):

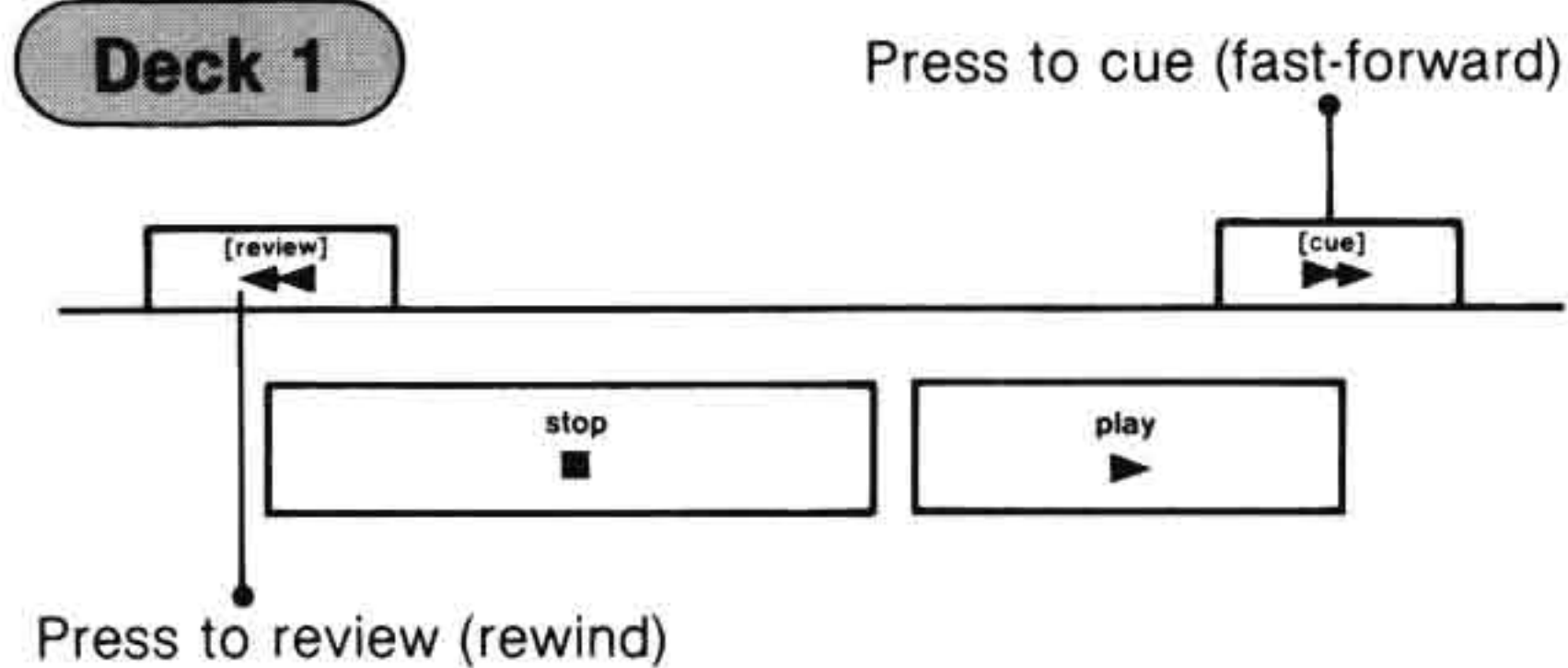
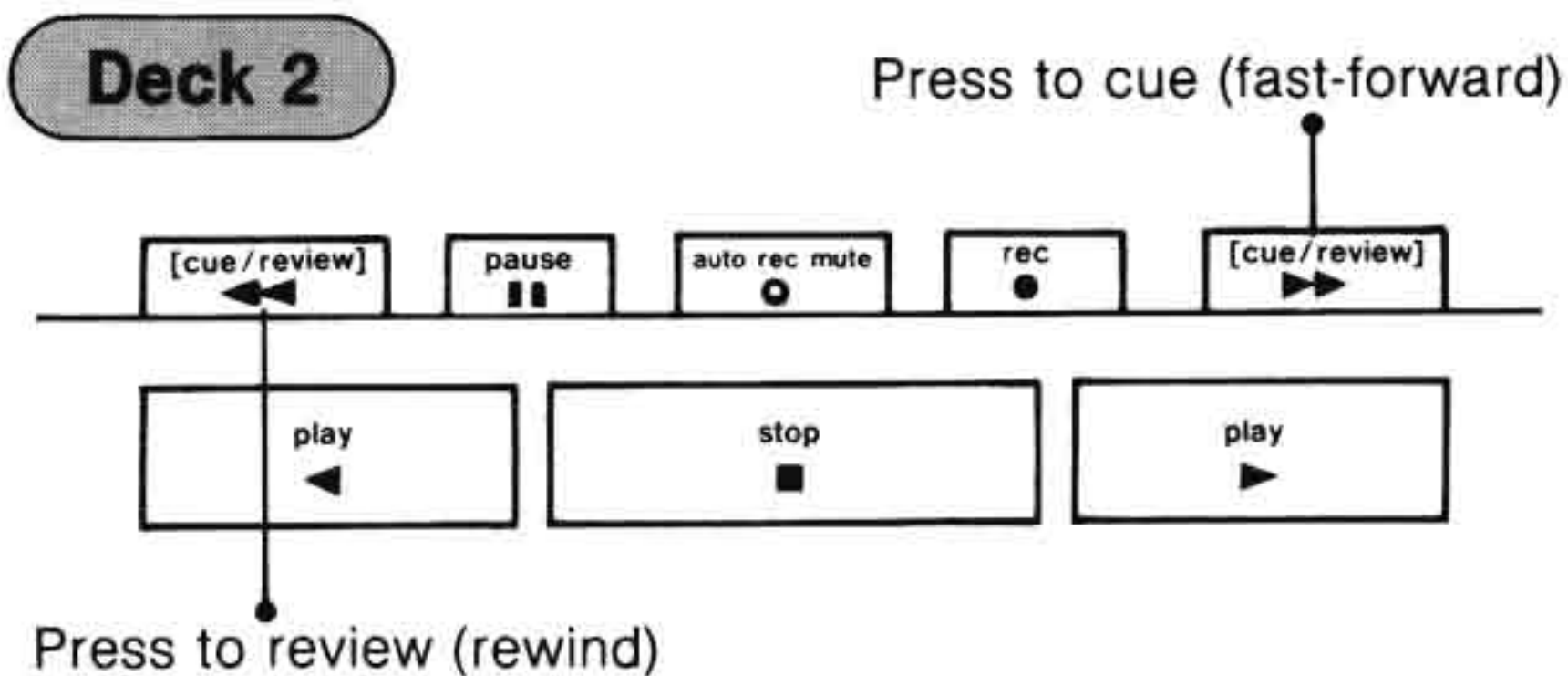

#### During playback of side "B" (reverse) (◀): (deck 2 only)

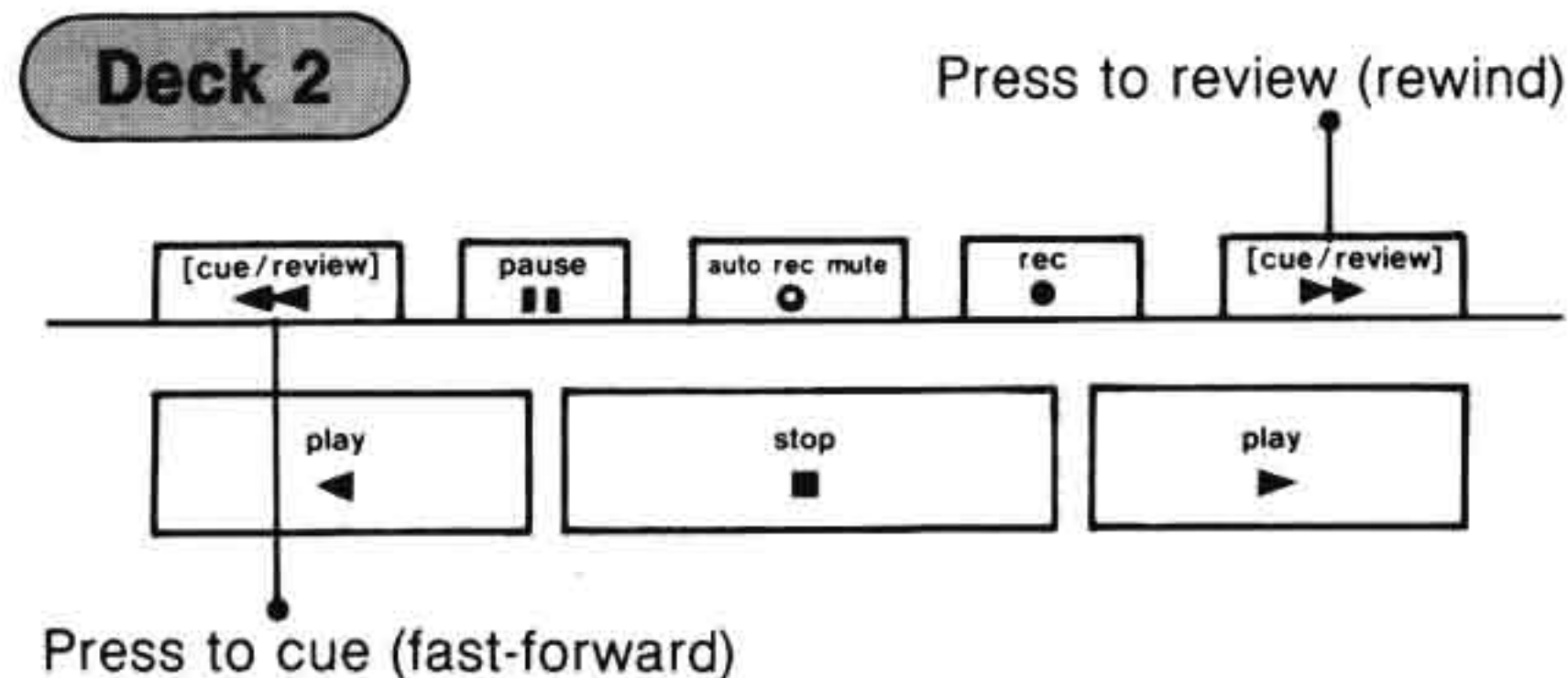

#### Note:

The cue/review function causes sounds to become high pitched. During this function, be sure to decrease the amplifier's volume to prevent damage to the speaker system's tweeters.

### To fast-forward or rewind the tape

While in the stop mode, press the appropriate button according to the figures above.

#### Note:

Cassette tapes in deck 1 and deck 2 can be advanced or rewound at the same time.

## To listen through headphones

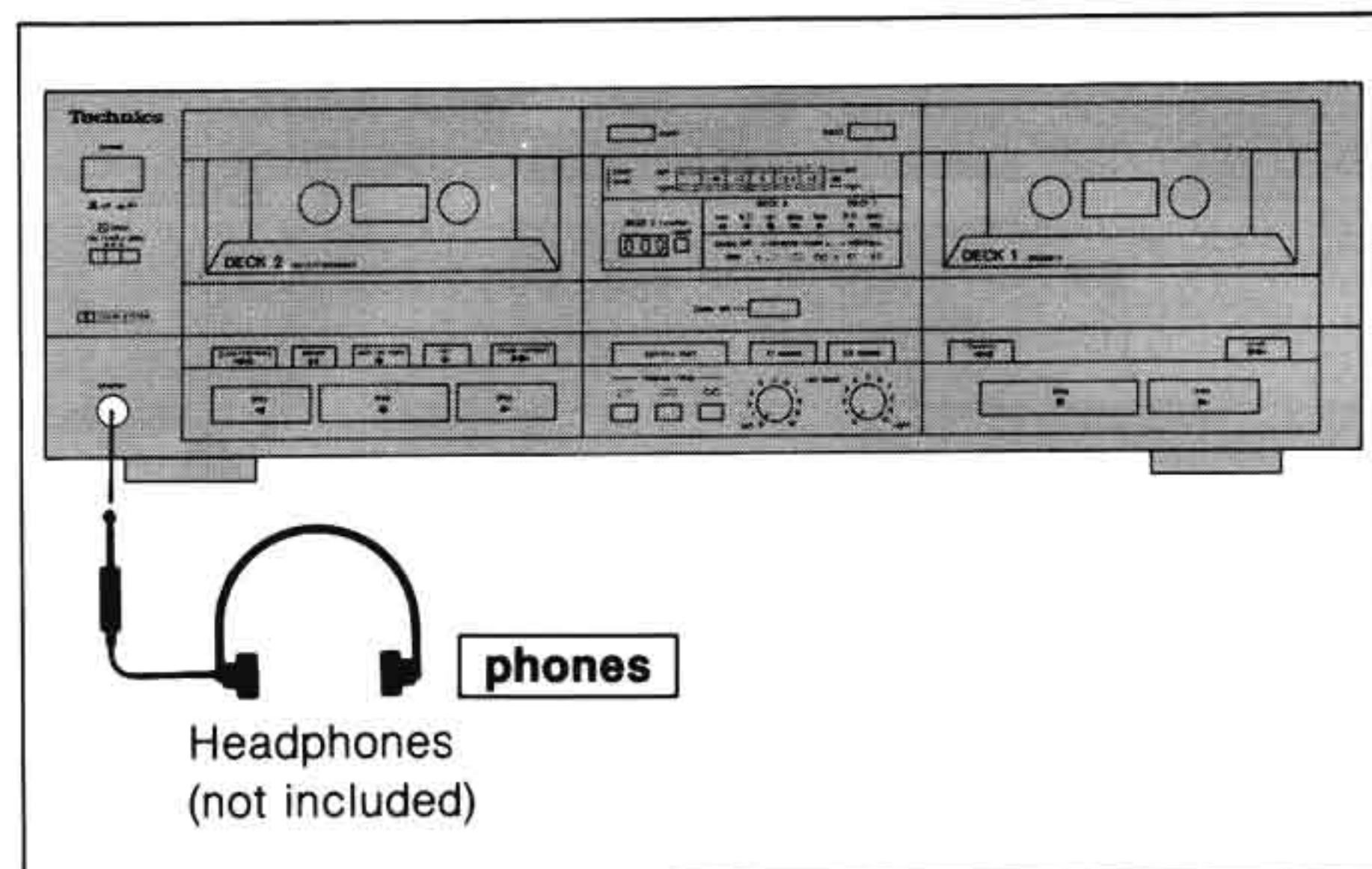

#### phones

Connect the headphones (not included) to the headphones jack.

Plug type: 1/4 inch phone plug, stereo type.

#### Note:

Avoid listening for prolonged periods of time to prevent hearing loss.

## Automatic-tape-select function

This unit is equipped with the automatic-tape-select feature; it automatically detects the type of tape being used, and then makes the suitable adjustments of the bias and equalization accordingly.

# Recording

(deck 2 only)

To record from a sound source other than another tape

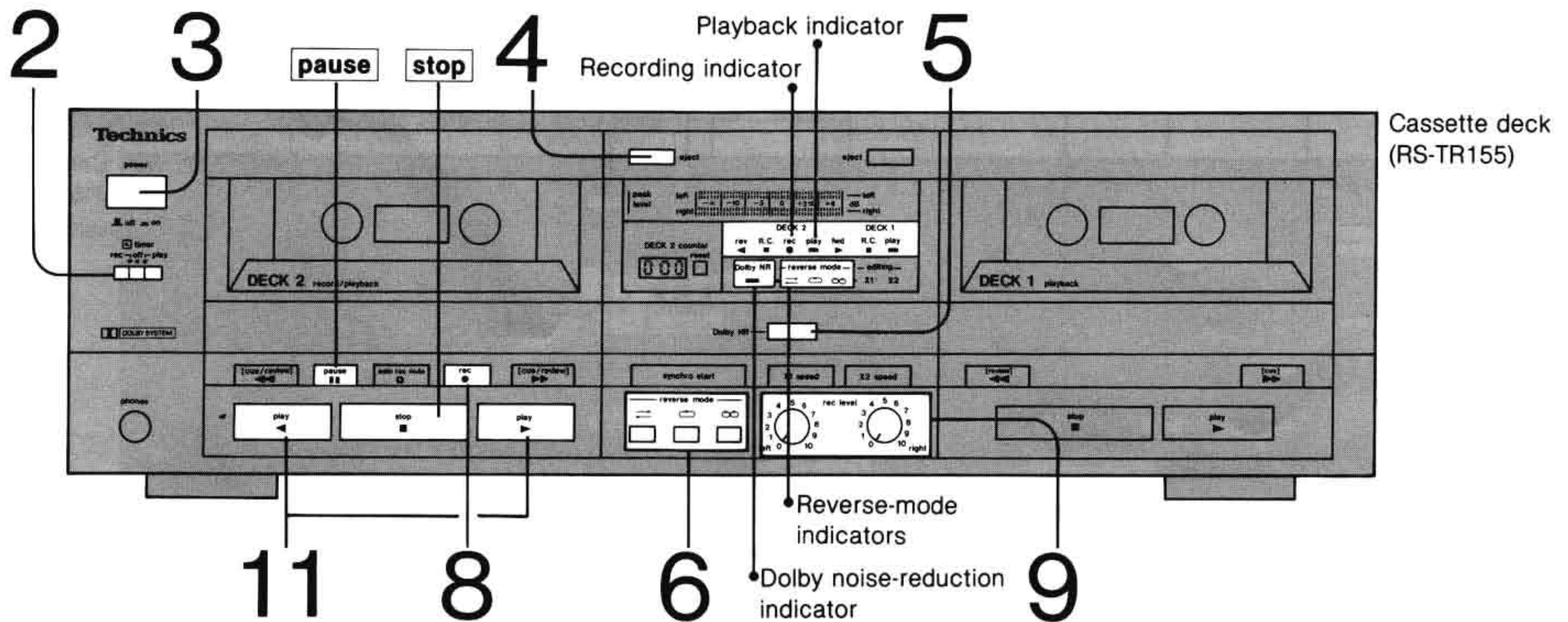

**1** Switch ON the amplifier, and select its "tape" input source.

**2** **timer** Switch OFF the timer switch.

**3** **power** Switch ON the power switch.

**4** **eject** Press the eject button, and then insert the cassette to be used for recording.

(The part of the cassette where the tape is exposed should face downward.)

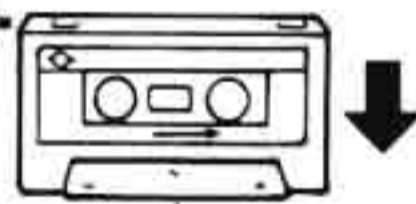

**5** **Dolby NR** To record with the Dolby noise-reduction system, press the Dolby noise-reduction button.

(The indicator will illuminate.)

**Dolby NR** **For RS-TR255**

Press the button corresponding to the Dolby noise-reduction system (B or C) to be used.

(The Dolby noise-reduction "B" or "C" indicator will illuminate.)

If neither Dolby noise-reduction system is to be used, press the button corresponding to the Dolby noise-reduction indicator that is illuminated. (The indicator will then switch OFF.)

**6** **reverse mode** Select the appropriate reverse mode.

[The reverse-mode indicator ("←" or "→") will illuminate.]

**←** Select this mode to record on one side only.

The recording will stop at the end of one side of the tape depending which side was selected.

**→** Select this mode to record on both sides.

The recording will be made on side "B" after recording on side "A". The tape will stop at the end of side "B".

**7** The sound source to be recorded should be played before the recording is started in order to adjust the recording level.

**8** **rec** Press the record button.

(The recording indicator will illuminate and the playback indicator will flash continuously. The unit will be in the recording stand-by mode.)

**9** **rec level** Adjust the recording level.

While watching the level on the meters, adjust the left and right "rec level" controls so that the peak indication is as high as possible, without exceeding the indication noted in the chart below.

Normal, CrO <sub>2</sub> tape	+3	Metal tape	+6
-------------------------------	----	------------	----

**10** Start the playback source from the beginning.

**11** Press the playback button.

- If only one side of the tape is to be recorded, press the playback button that corresponds to that side.
- To record on both sides of the tape, press the "A" side playback button (▶).

(The playback indicator will illuminate steadily, and the recording will begin.)

### Notes:

- Make sure the edit-recording tape-speed buttons are in the off position.
- If this unit is used in combination with a Technics compact disc player that has a synchro-edit terminal, switch OFF the compact disc edit indicator on the compact disc player (by pressing the stop button on the compact disc player).

### ■ To temporarily stop recording

**pause** Press the pause button.

(The playback indicator will begin flashing.)

To resume recording, press the playback button corresponding to the side of the tape being recorded upon.

### ■ To stop recording

**stop** Press the stop button.

# Edit-Recording

Changes can be made while recording from one tape to another

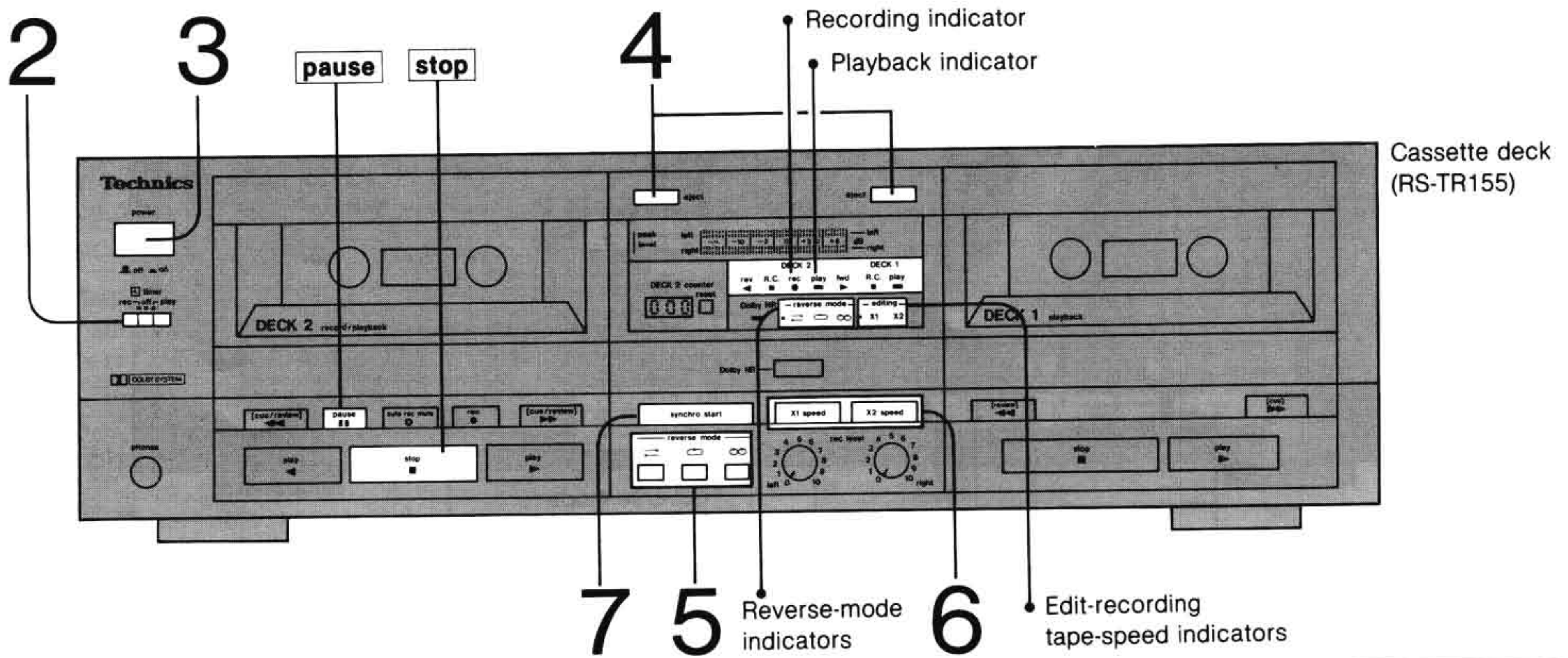

**1** Switch ON the amplifier.

**2** **timer** Switch OFF the timer switch.

**3** **power** Switch ON the power switch.

**4** **eject** Press and insert the cassette for recording into deck 2. Then insert the cassette for playback into deck 1.

**5** **reverse mode** Select the appropriate reverse mode.

[The reverse-mode indicator ("⇌" or "↔") will illuminate.]

⇌ **Select this mode to record on one side only.**

The recording will stop at the end of one side of the tape, depending which side was selected.

↔ **Select this mode to record on both sides.**

The recording will be made on side "B" after recording on side "A". The tape will stop at the end of side "B". (When the playback in the "A" side by deck 1 has finished, tape movement in deck 1 will stop and deck 2 will change to the recording stand-by mode.)

**6** **speed** Select the speed at which the recording will be made.

[The edit-recording tape-speed indicator ("×1" or "×2") will illuminate.]

- × 1: For operation at the normal tape speed
- × 2: For operation at the high tape speed

**7** **synchro start** Press the synchro-start button.

(The recording will begin.)

In order to avoid mis-operations later, be sure to switch OFF the edit-recording tape-speed button (the edit-recording tape-speed indicator illumination stops) after the edit-recording has finished.

## Notes

- Edit-recordings cannot be made from deck 2 to deck 1.
- Recording level as well as equalizer effects and Dolby noise-reduction effects are recorded on to the tape in deck 2 exactly as they were originally recorded on the tape in deck 1.
- The Dolby noise-reduction systems have no effect during an edit-recording (while the edit-recording tape-speed indicator is illuminated). To listen to music recorded by a Dolby noise-reduction system while making an edit-recording, reduce the treble range by using the treble tone control on the amplifier.
- While an edit-recording is in progress, you can enjoy some other source. Select the desired sound source by using the input selectors on the amplifier, and start the performance.

## ■ To temporarily stop an edit-recording

**pause** Press the pause button.

(The playback indicator will begin flashing, and playback will continue on deck 1.)

To resume recording, press the playback button corresponding to the side of the tape being recorded upon.

## ■ To stop an edit-recording

**stop** Press the stop button of deck 2.

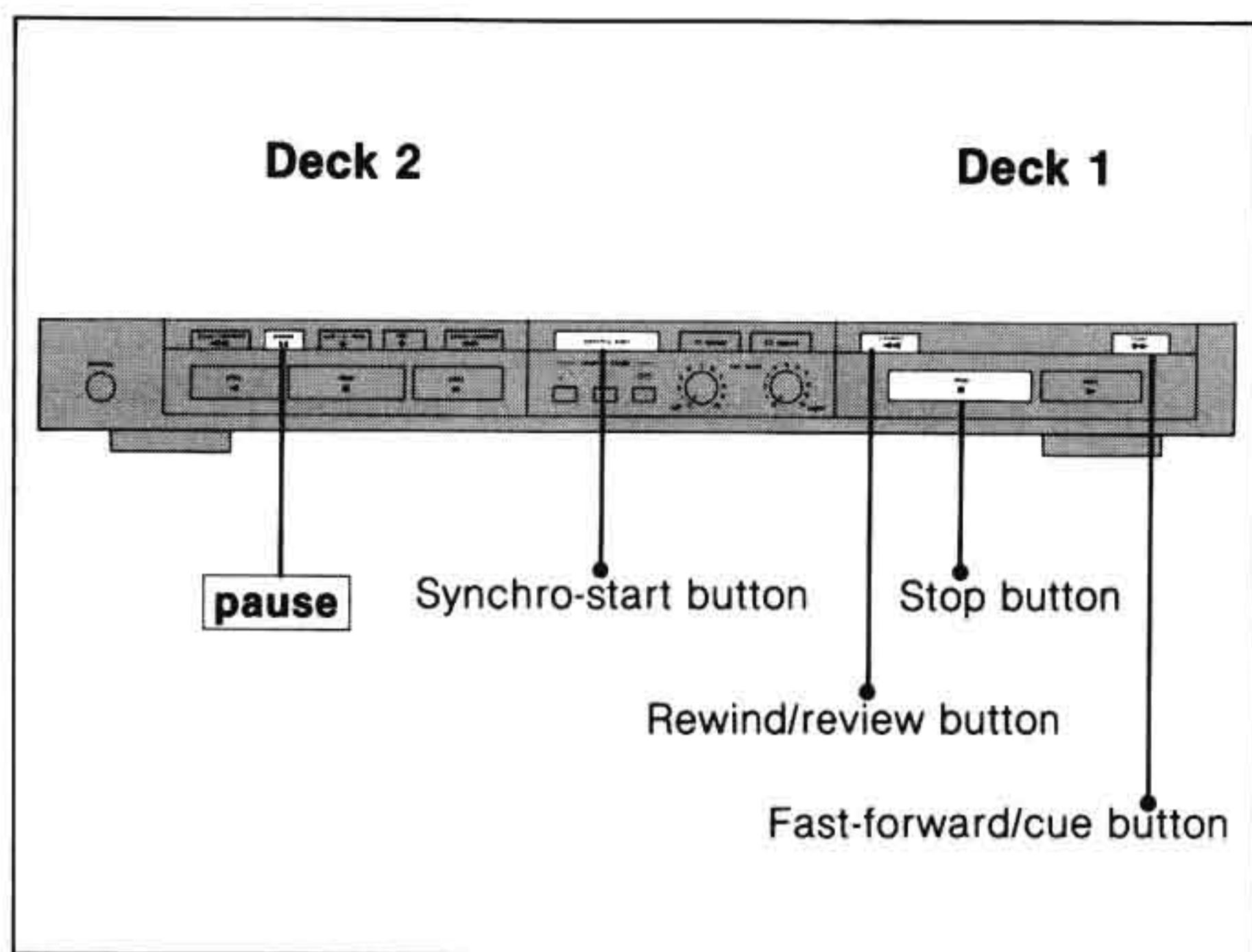

## ■ To omit unwanted material during edit-recording

**pause** Press the pause button.

Deck 2 will change to the recording stand-by mode, and playback will continue on deck 1.

Press the playback button corresponding to the side of the tape being recorded when the tape reaches a point where you want to record.

## ■ To locate a certain tune while an edit-recording is being made

**1. Press the stop button of deck 1.**

(A silent interval of about 4 seconds will then be made on the tape in deck 2, and then deck 2 will change to the recording stand-by mode.)

**2. Press the fast-forward/cue or rewind/review button of deck 1 and locate the desired tune.**

**3. To resume recording, press the synchro-start button.**

# Convenient Features for Recording

## Compact disc synchro-edit-recording

When a Technics compact disc player with the compact disc editing function is used in combination with this unit, recordings can be made on side "A" and side "B" of the tape, without interruptions of tracks, in conjunction with the tape length.

### Procedure for this unit

**1. Follow steps 1 through 9 in the section concerning recording.** (Refer to page 11.)

### Procedure for the compact disc player

**2. Press the stop button.** (Disc play will stop.)

**3. Press the edit-tape-length button and specify the length of the tape to be used.**

The tracks to be recorded to side "A" of the tape and those to be recorded to side "B" will then be automatically selected according to the tape's length.

**4. Press the play button.**

The recording will start at the same time that play starts at the compact disc player.

For more detailed information, refer to the operating instructions of the Technics compact disc player to be used.

### Notes:

- Recordings cannot be made on the leader tape (attached to each end of recording tape), so advance the tape slightly from its end before starting a recording. Also check to be sure that side A ("fwd") indicator is illuminated.
- If the CD program contents to be recorded on side "A" of the tape are shorter than the actual tape length, this unit will continue to record until it reaches the end of side "A", while the compact disc player switches to the pause mode. At the end of side "A", deck 2 automatically switches to side "B" and after few seconds the compact disc player will resume play.
- To stop a synchro-edit recording from the compact disc player, be sure to press the stop button on the compact disc player twice and then press the stop button on this unit.
- When a synchro-edit recording from the compact disc player finishes, press the stop button of the compact disc player twice so that the edit indicator is switched OFF.

## Automatic-record-muting function

By simply pressing the automatic-record-muting button while a recording is being made, a silent interval (which is necessary for locating the beginning of a tune during playback) can be made.

Automatic-record-muting button

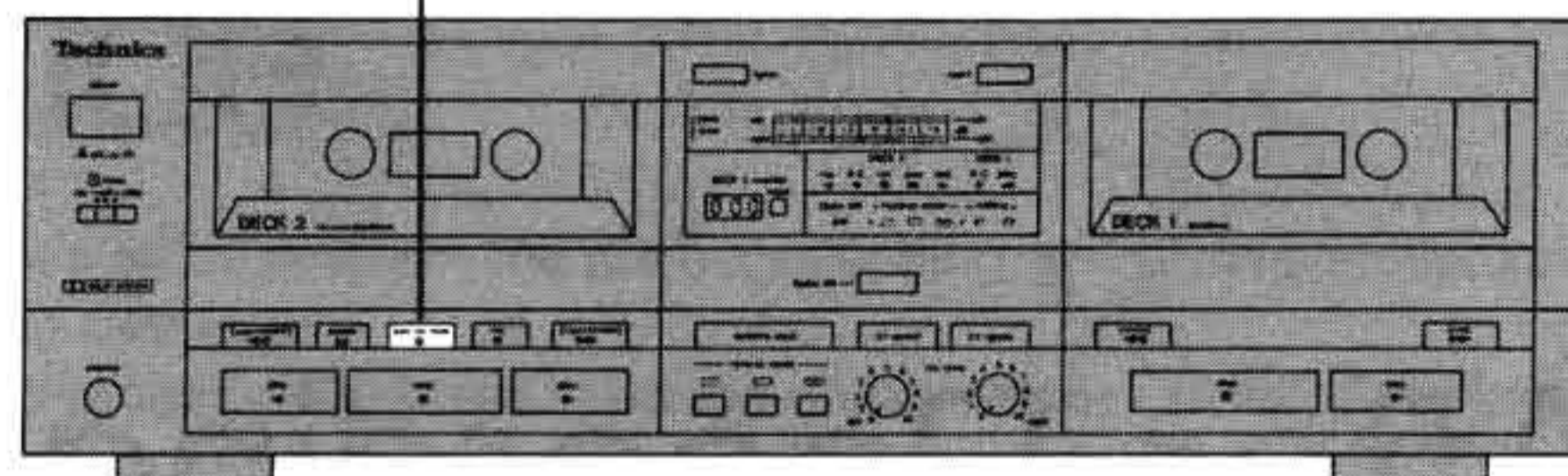

This feature is also convenient for omitting unwanted material such as commercial messages, etc. during recording.

**While recording, press the automatic-record-muting button one time.**

**To resume recording, press the playback button corresponding to the side being recorded.**

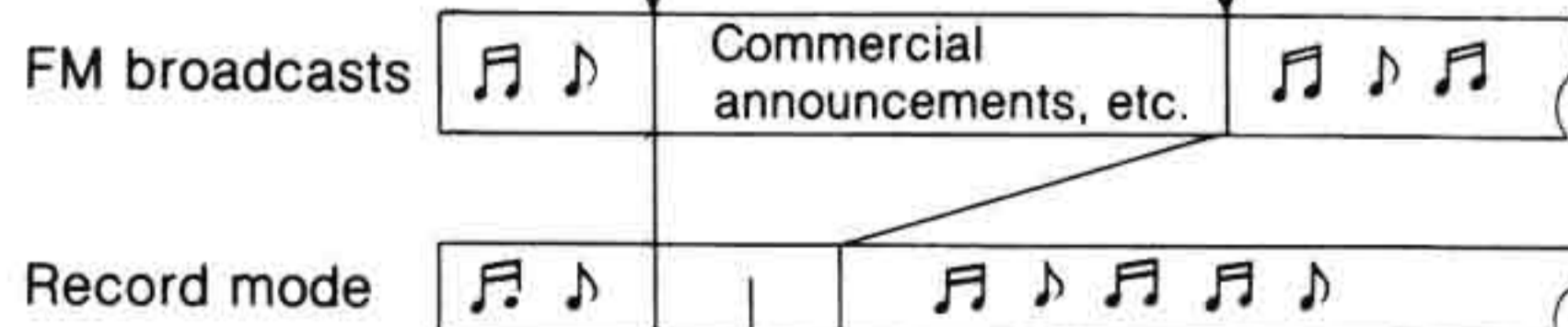

This unit will record a silent interval (4 seconds long) between tunes, and then will change to the recording stand-by mode.

## ■ To make a silent interval of more than 4 seconds on the tape

**Press and hold the automatic-record-muting button for the necessary number of seconds.**

The unit will change to the recording stand-by mode when the button is released.

# Timer Recording/Playback

If an audio timer (not included) is connected to this unit, recording of a radio broadcast, or tape playback, will automatically begin at the preset time.

Timer recording or playback is also possible by using a tuner with a timer.

Connect the AC power cord of this unit to the power source outlet of the timer. (See the operating instructions of the timer for detailed information.)

## Note:

Playback by one deck only can only be done by tape deck 2.

## Timer recording (deck 2 only)

**1 Prepare for recording.**  
Follow steps 1 through 9 of "Recording" on page 11. After adjusting the recording level, press the stop button. Select the tape side ("A" or "B").

**2 Set the timer to the desired recording-start time.**  
(Power will be switched OFF.)

**3 Set the timer switch to the "rec" position.**  
(At the specified time, the power will be switched ON and the audio source will be recorded.)

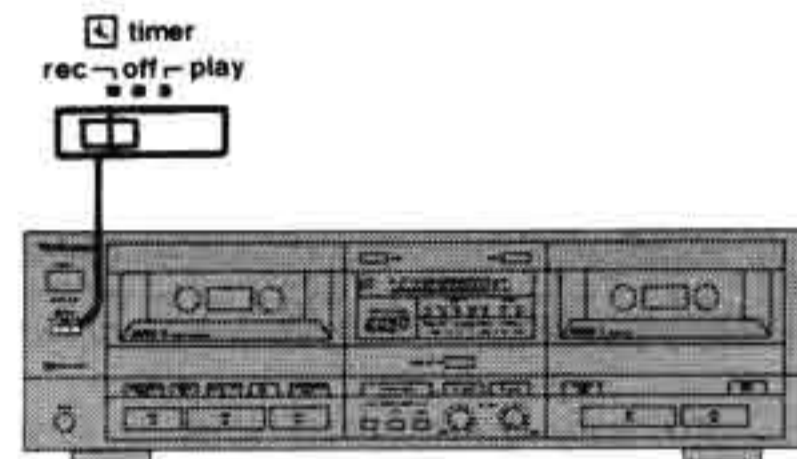

## After setting the timer

Be sure that the power switch is set to the "on" position.

## Timer playback

Series playback (deck 2 to deck 1) is also possible.

**1 Rewind the tape to the position from which you want playback to begin.**  
(Refer to pages 8 – 10.)  
Select the tape side ("A" or "B") to be played back.

**2 Set the timer to the desired playback-start time.**  
(Power will be switched OFF.)

**3 Set the timer switch to the "play" position.**  
(At the specified time, the power will be switched ON and the playback will begin.)

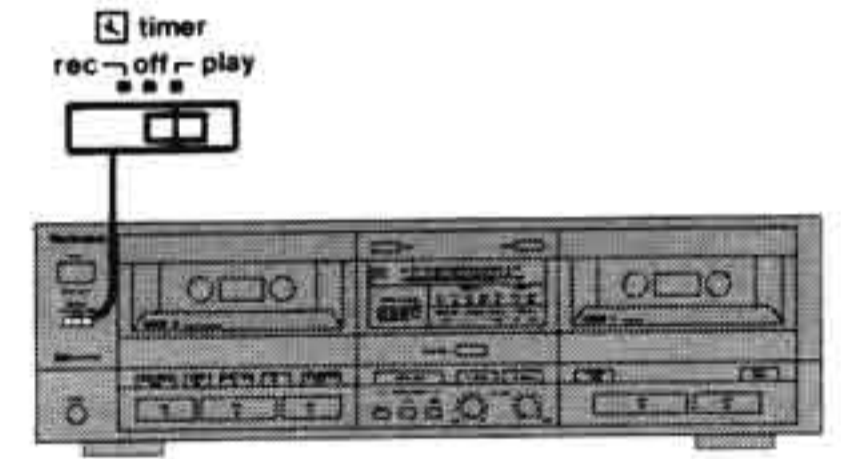

## After setting the timer

Be sure that the power switch is set to the "on" position.

# After Recording

## To prevent erasure of recorded sounds

Remove the erase-prevention tabs (thus preventing recording).

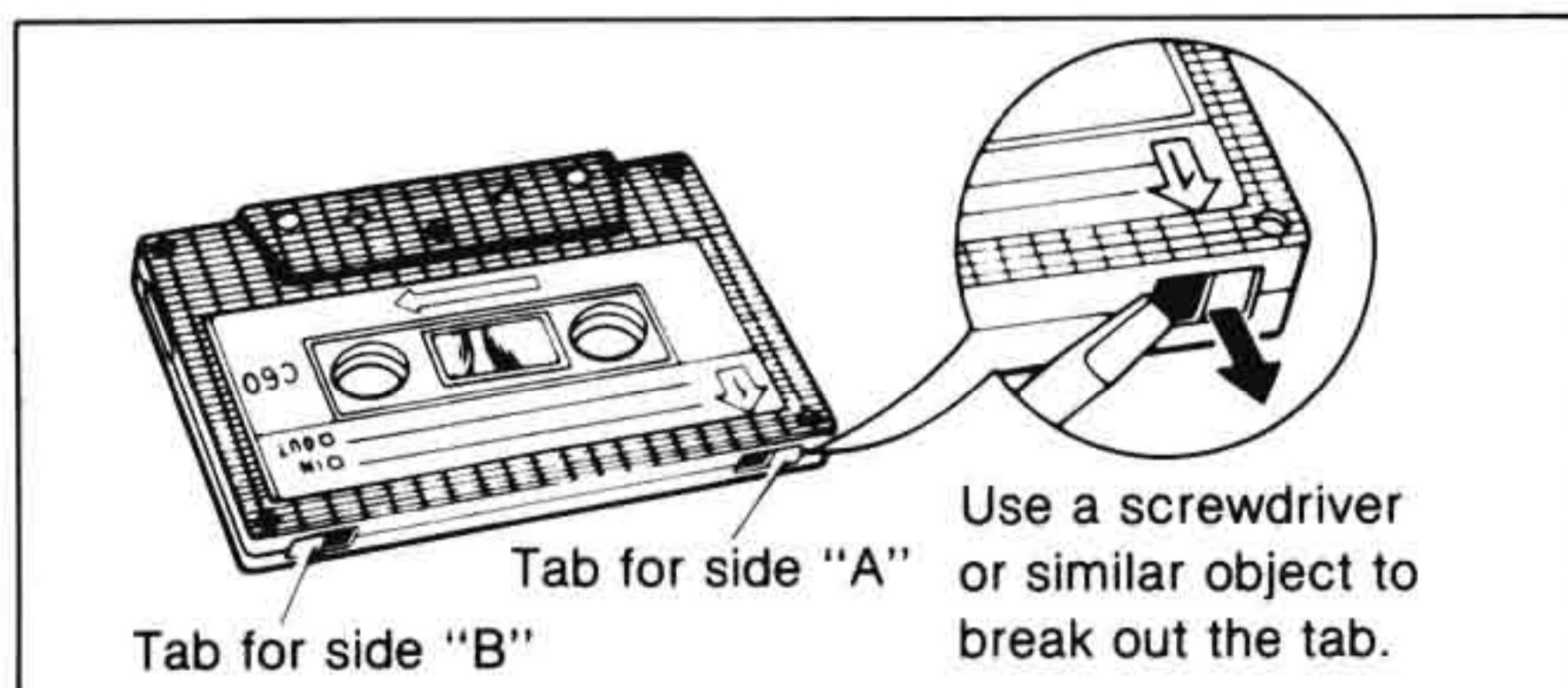

## To re-record on a protected cassette

Cover the slot with adhesive tape.

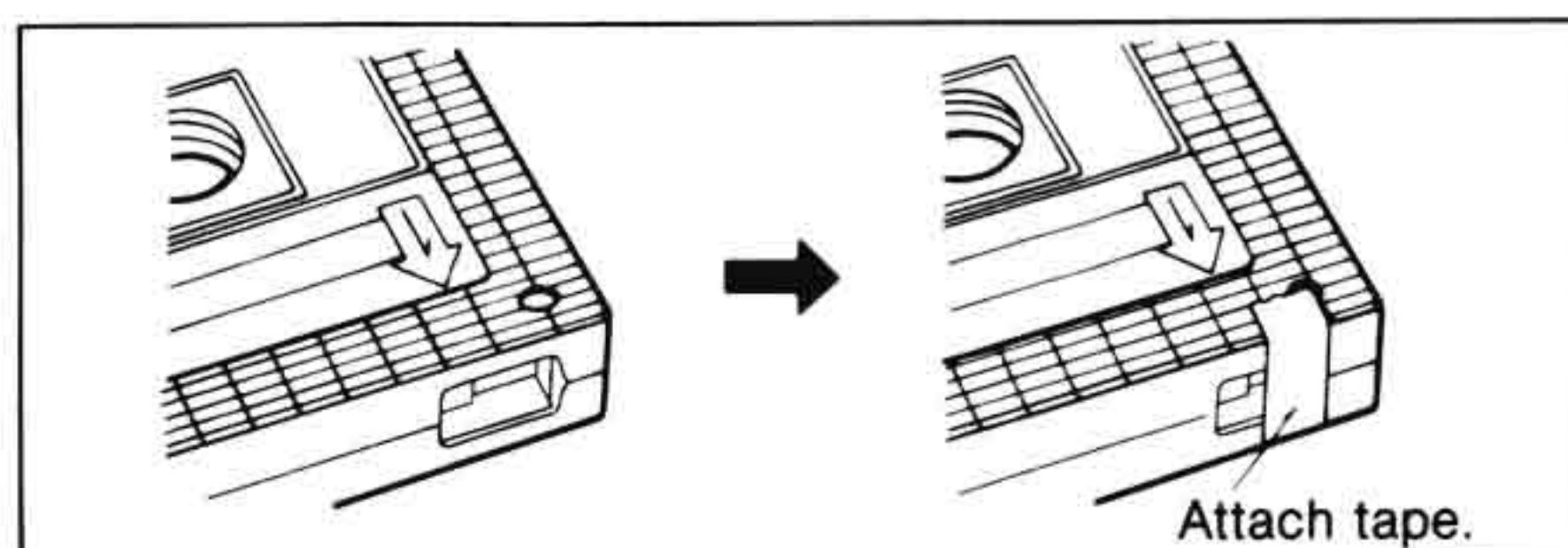

## To erase recorded sounds

When new recordings are made on a pre-recorded tape, all sounds recorded on that portion of the tape are automatically erased. To erase a tape without making a new recording, follow the steps below.

- 1. Insert the recorded cassette into the cassette holder of deck 2.**
- 2. Set the recording-level controls to "0".**
- 3. Set the reverse-mode selector to either one-side only (↔) or both sides (↔).**
- 4. Switch OFF the Dolby noise-reduction button.**  
(The indicator will then switch OFF.)

### For RS-TR255

**Press the Dolby noise-reduction button corresponding to the Dolby noise-reduction indicator that is illuminated.**  
(The indicator will then switch OFF.)

- 5. Press the record button.**
- 6. Press the playback button corresponding to the side to be erased.**

# Technical Specifications

## ■ CASSETTE DECK SECTION

<b>Deck system</b>	Stereo cassette deck
<b>Track system</b>	4-track, 2-channel
<b>Heads</b>	
(tape deck 1) Play	Permalloy head
(tape deck 2) Rec/play	Permalloy head
Erasing	Double-gap ferrite head
<b>Motors</b>	
(tape deck 1) Capstan/reel table drive	DC servo motor
(tape deck 2) Capstan/reel table drive	DC servo motor
<b>Recording system</b>	AC bias
Bias frequency	80 kHz
<b>Erasing system</b>	AC erase
<b>Tape speed</b>	4.8 cm/sec. (1-7/8 ips)
<b>Frequency response (w/o Dolby NR)</b>	
NORMAL	20 Hz~16 kHz
CrO <sub>2</sub>	20 Hz~16 kHz
METAL	20 Hz~18 kHz
<b>S/N</b> (signal level = max recording level, CrO <sub>2</sub> type tape)	

### For RS-TR155

Dolby NR on	66 dB (CCIR)
Dolby NR off	56 dB (A weighted)

### For RS-TR255

Dolby C NR on	74 dB (CCIR)
Dolby B NR on	66 dB (CCIR)
Dolby NR off	56 dB (A weighted)

<b>Wow and flutter</b>	0.1 % (WRMS)
<b>Fast forward and rewind times</b>	Approx. 110 seconds with C-60 cassette tape
<b>Input sensitivity and impedance</b>	
LINE	60 mV/47 kΩ
<b>Output voltage and impedance</b>	
LINE	400 mV/800 Ω
HEADPHONES	30 mV/8 Ω
LOAD IMPEDANCE	(8 Ω~600 Ω)

## ■ GENERAL

<b>Power consumption</b>	15 W
<b>Power supply</b>	AC 120 V, 60 Hz
<b>Dimensions (W × H × D)</b>	430 × 136 × 290 mm (16-15/16" × 5-3/8" × 11-13/32")
<b>Weight</b>	4.8 kg (10.6 lb.)

# Troubleshooting Guide

Before requesting service for this unit, check the chart below for a possible cause of the problem you are experiencing. Some simple checks or a minor adjustment on your part may eliminate the problem and restore proper operation.

If you are in doubt about some of the check points, or if the remedies indicated in the chart do not solve the problem, refer to the directory of Authorized Service Centers (enclosed with this unit) to locate a convenient service center, or consult your Technics dealer for instructions. (In U.S.A. consult MSC Authorized Servicenters for detailed instructions.)

Problem	Probable cause(s)	Suggested remedy
<b>While using the tape deck</b>		
<b>Tape moves but no sound is heard.</b>	The volume control of the amplifier is set to its minimum position.	• Adjust the volume control to the desired level.
	The input selector of the amplifier is not set to the "tape 1" position.	• Set to the "tape 1" position.
<b>Distorted sound.</b>	The recording level is too high.	• Select the appropriate recording level.
<b>Previously recorded sound has not been erased.</b>	Erase head is dirty.	• Clean the head.
<b>Sound output is hoarse or unsteady.</b>	Heads are dirty	• Clean the heads.
	Tape is damaged.	• Try operation with a new cassette; if there is no problem with the new cassette, discard the damaged cassette.
<b>Poor sound quality (especially in the high treble and low bass ranges)</b>	The correct Dolby noise-reduction button is not set.	• Set it to the correct position.
<b>Sound is low, poor tone, intermittent sound, noise.</b>	Heads, capstan and/or pinch roller are dirty or tape is damaged.	• Clean the heads, capstan and/or pinch roller, or try a new cassette.
<b>Recording is not possible.</b>	The recording level control is at the "0" position.	• Select the appropriate recording level.
	One of the edit-recording tape-speed indicators is illuminated.	• Switch OFF (by pressing the corresponding edit-recording tape-speed button) whichever edit-recording tape-speed indicator that is illuminated.

# Product Service

## ■ Warning concerning removal of covers

The unit should be serviced by qualified technicians only. No service information is provided for customers. Your product is designed and manufactured to ensure a minimum of maintenance. However, should your unit ever require service, a nationwide system of factory servicenters and AUTHORIZED INDEPENDENT SERVICENTERS is maintained to support your product's warranty.

(In the U.S.A., call 1-800-447-4700 to locate the MSC Authorized Servicenter nearest you.)

---

**Panasonic Company, Division of  
Matsushita Electric Corporation of America**  
One Panasonic Way  
Secaucus, New Jersey 07094

**Panasonic Hawaii, Inc.**  
99-859 Iwaiwa Street  
P.O. Box 774  
Honolulu, Hawaii 96808-0774

**Panasonic Sales Company,  
Division of Matsushita Electric  
of Puerto Rico, Inc.**  
San Gabriel Industrial Park  
65TH Infantry Ave. KM. 9.5  
Carolina, P.R. 00630

**Matsushita Electric of Canada Limited**  
5770 Ambler Drive, Mississauga,  
Ontario L4W 2T3

Printed in Japan

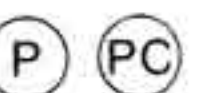

**RQT0068P-1**  
H0289A3059